

# VITA V

Operating Manual



**Edition:** 10/23

### **Copyright**

Copyright by Carl Valentin GmbH

Subject to modifications.

All rights, including those regarding the translation, are reserved.

No part of this document may be reproduced in any form (print, photocopy, or any other method) or edited, copied, or distributed electronically without written permission from Carl Valentin GmbH.

### **Trademarks**

All named brands or trademarks are registered brands or registered trademarks of their respective owners and may not be separately labelled. It must not be concluded from the missing labelling that it is not a registered brand or a registered trademark.

### **Topicality**

Information on the scope of delivery, appearance, performance, dimensions, and weight reflect our knowledge at the time of printing.

Due to constant further development of our products discrepancies between documentation and product can occur.

Please check [www.carl-valentin.de](http://www.carl-valentin.de) for the latest update.

### **Terms and Conditions**

Deliveries and services are effected under the General Conditions of Business of Carl Valentin GmbH

### **Licences**

**CE** Low-Voltage Directive (2014/35/EU)  
Electromagnetic Compatibility Directive (2014/30/EU)  
RoHS Directive (2011/65/EU)



### **Carl Valentin GmbH**

Postfach 3744  
78026 Villingen-Schwenningen  
Neckarstraße 78 – 86 u. 94  
78056 Villingen-Schwenningen

Phone +49 7720 9712-0  
Fax +49 7720 9712-9901

E-Mail [info@carl-valentin.de](mailto:info@carl-valentin.de)  
Internet [www.carl-valentin.de](http://www.carl-valentin.de)

## Table of Contents

<b>1</b>	<b>Introduction.....</b>	<b>5</b>
1.1	General Instructions .....	5
1.2	Intended Use .....	5
1.3	Important Notes .....	6
1.4	Connector Pin Assignment (Printer Rear) .....	7
<b>2</b>	<b>Safety Notes.....</b>	<b>9</b>
2.1	Operating Conditions .....	10
<b>3</b>	<b>Technical Data .....</b>	<b>15</b>
3.1	Control Inputs and Outputs .....	18
<b>4</b>	<b>Installation.....</b>	<b>25</b>
4.1	Set up the Label Printer.....	25
4.2	Connect the Label Printer.....	26
4.3	Switch the Label Printer On and Off.....	26
4.4	Initial Operation of the Label Printer.....	27
<b>5</b>	<b>Load Media.....</b>	<b>29</b>
5.1	Load Media .....	29
5.2	Load Fanfold Labels .....	33
5.3	Load Transfer Ribbon.....	34
<b>6</b>	<b>Function Menu .....</b>	<b>37</b>
6.1	Operation Panel.....	37
6.2	Menu Structure .....	38
6.3	Print Settings .....	42
6.4	Label Layout .....	43
6.5	Device Settings.....	45
6.6	Network .....	48
6.7	Password.....	49
6.8	Interface.....	51
6.9	Emulation.....	52
6.10	Date & Time.....	53
6.11	Service Functions .....	54
6.12	Main Menu.....	58
<b>7</b>	<b>Options .....</b>	<b>59</b>
7.1	Cutter .....	59
7.2	Dispenser I/O.....	61
7.3	WLAN .....	65
7.4	Scanner .....	66
<b>8</b>	<b>SD Card / USB Memory Stick .....</b>	<b>69</b>
8.1	General Information.....	69
8.2	Display Structure .....	69
8.3	Navigation.....	70
8.4	Define User Directory .....	71
8.5	Load Layout.....	72
8.6	File Explorer .....	73
8.7	Firmware Update .....	78
8.8	Filter.....	78
<b>9</b>	<b>Maintenance and Cleaning .....</b>	<b>79</b>
9.1	General Cleaning.....	80
9.2	Clean the Transfer Ribbon Drawing Roller .....	80
9.3	Clean the Pressure Roller .....	81
9.4	Clean the Printhead.....	82
9.5	Clean the Label Photocell .....	83

9.6	Replace the Printhead (General).....	84
9.7	Replace the Printhead.....	85
9.8	Adjust the Printhead.....	87
<b>10</b>	<b>Error Correction.....</b>	<b>89</b>
<b>11</b>	<b>Additional Information.....</b>	<b>99</b>
11.1	Column Printing.....	99
11.2	Hotstart.....	100
11.3	Backfeed/Delay.....	102
11.4	Photocells.....	104
<b>12</b>	<b>Environmentally-Friendly Disposal.....</b>	<b>105</b>
<b>13</b>	<b>Index.....</b>	<b>107</b>

# 1 Introduction

## 1.1 General Instructions

Basic information and warning references with the corresponding signal words for the danger level are as follows specified in this manual:



**DANGER** identifies an extraordinarily great and immediate danger which could lead to serious injury or even death.



**WARNING** identifies a possible would could lead to serious bodily injury or even death if sufficient precautions are not taken.



**WARNING** of cutting injuries.  
Pay attention that cutting injuries caused by blades, cutting devices or sharp-edged parts are avoided.



**WARNING** of hand injuries.  
Pay attention that hand injuries caused by closing mechanical parts of a machine/equipment are avoided.



**WARNING** of hot surfaces.  
Pay attention so as not to come into contact with hot surfaces.



**CAUTION** indicates a potentially dangerous situation which could lead to moderate or light bodily injury or damage to property.



**NOTICE** gives you tips. They make a working sequence easier or draw attention to important working processes.



Gives you tips on protecting the environment.



Handling instruction



Optional accessories, special fittings

Datum

Information in the display

## 1.2 Intended Use

The label printer is a state-of-the-art device which complies with the recognized safety-related rules and regulations. Despite this, a danger to life and limb of the user or third parties could arise and the label printer or other property could be damaged while operating the device.

The label printer may only be used while in proper working order and for the intended purpose. Users must be safe, aware of potential dangers and must comply with the operating instructions. Faults, in particular those which affect safety, must be remedied immediately.

The label printer is solely intended to print suitable media which have been approved by the manufacturer. Any other or additional use is not intended. The manufacturer/supplier is not liable for damage resulting from misuse. Any misuse is at your own risk.

Intended use includes heeding the operating manual, including the maintenance recommendations/regulations specified by the manufacturer.

### **1.3 Important Notes**

The label printer can be used in thermal as well as in thermal transfer applications.

The label printer is equipped with eight vector, six bitmap and six proportional fonts. It can be printed inverse, in italic format or 90 degrees turned fonts.

The handling of our durable label printers is easy and comfortable. The parameter settings are made with the keys of the foil keyboard. At each time the graphic display shows the current status.

Time-saving firmware update is possible by interface. As default, the print module is equipped with a serial, USB and Ethernet interface. The print module automatically recognizes by which interface it is controlled.

## 1.4 Connector Pin Assignment (Printer Rear)

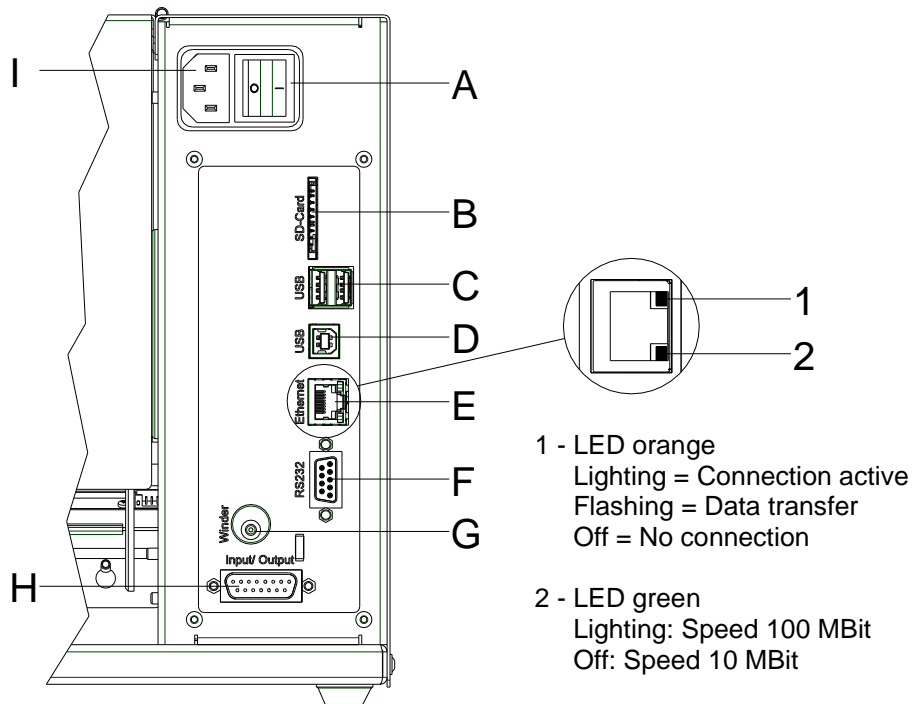

Figure 1

- A Switch On/Off
- B Plug-in for SD card
- C 2 x USB host
- D USB 2.0 Hi-Speed Device (for connection PC)
- E Ethernet 10/100 interface
- F Serial interface RS-232
- G Winder connection



### CAUTION!

The label printer can be damaged by non-compliant winders.

⇒ Attach only winders of Carl Valentin.

- H External output/input (option)
- I Power supply





## 2 Safety Notes

The printer is designed for power supply systems from 110 ... 230 V AC. Connect the label printer only to electrical outlets with a ground contact.

Couple the label printer to devices using extra low voltage only.

Before making or undoing connections, switch off all devices involved (computer, printer, accessories etc.).

Operate the label printer in a dry environment only and do not get it wet (sprayed water, mist etc.).

Maintenance and servicing work can only be carried out by trained personnel.

Operating personnel must be trained by the operator on the basis of the operating manual.

If the label printer is operated with the cover open, ensure that clothing, hair, jewellery and similar personal items do not contact the exposed rotating parts.

The print unit and parts of it (e.g. printhead) can get hot during printing. Do not touch the printhead during operation. Cool down the print unit before changing material, removal or adjustment.

Never use highly inflammable consumables.

There is a risk of injury at the tear-off edge. If the tear-off edge is not used, attach the edge protection profile.

Carry out only the actions described in these operating instructions. Any work beyond this may only be performed by the manufacturer or upon agreement with the manufacturer.

Unauthorized interference with electronic modules or their software can cause malfunctions.

Other unauthorized work or modifications to the direct print module can endanger operational safety.

Always have service work done in a qualified workshop, where the personnel have the technical knowledge and tools required to do the necessary work.

There are warning stickers on the direct print modules that draw your attention to dangers. Therefore the warning stickers are not to be removed as then you and others cannot be aware of dangers and may be injured.



### **DANGER!**

Danger to life and limb from power supply!

⇒ Do not open the casing.

## 2.1 Operating Conditions

**Before initial operation and during operation** these operating conditions have to be observed to guarantee safe and interference-free service of our printers.

Therefore please carefully read these operating conditions.

Shipment and storage of our printers are **only** allowed in original packing.

Installation and initial operation of printer is only allowed if operating conditions were **fulfilled**.

Initial operation, programming, operation, cleaning and service of our printers are only recommended after careful study of our manuals.

Operation of printer is only allowed by especially trained persons.



### NOTICE!

Perform trainings regularly.

Content of the training are chapter 2.1 (Operating Conditions), chapter 5 (Load Media) and chapter 9 (Maintenance and Cleaning).

These indications are also valid for someone else's equipment supplied by us.

Only use original spare and exchange parts.

Please contact the manufacturer with respect to spare/wear parts.

### Conditions for installation place

The installation place of printer should be even, free of vibration and currents of air are to be avoided.

The printers have to be installed to ensure optimal operation and servicing.

### Installation of power supply

The installation of the power supply to connect our printers has to be effected according to the international rules and regulations, especially the recommendations of one of the three following commissions:

- International Electronic Commission (IEC)
- European Committee for Electro technical Standardisation (CENELEC)
- Verband Deutscher Elektrotechniker (VDE)

Our printers are constructed according to VDE and have to be connected to a grounded conductor. The power supply has to be equipped with a grounded conductor to eliminate internal interfering voltage.

**Technical data of power supply**

Power line voltage and power line frequency: See type plate

Allowable tolerance of power line voltage:  
+6 % ... -10 % of nominal value

Allowable tolerance of power line frequency:  
+2 % ... -2 % of nominal value

Allowable distortion factor of power line voltage:  $\leq 5\%$

**Anti-Interference measures:**

In case your net is infected (e.g. by using thyristor controlled machines) anti-interference measures have to be taken. You can use one of the following possibilities:

- Provide separate power supply to our printers.
- In case of problems please connect capacity-decoupled isolation transformer or similar interference suppressor in front of our printers.

**NOTICE!**

This is a machine of type A. This machine can cause interferences in residential areas; in this case it can be required from operator to accomplish appropriate measures and be responsible for it.

**Connecting lines to external machines**

All connecting lines have to be guided in shielded lines. Shielding has to be connected on both sides to the corner shell.

It is not allowed to guide lines parallel to power lines. If a parallel guiding cannot be avoided a distance of at least 0.5 m has to be observed.

Temperature of lines between:  $-15 \dots +80 \text{ }^\circ\text{C}$ .

It is only allowed to connect devices which fulfil the request 'Safety Extra Low Voltage' (SELV). These are generally devices which are checked corresponding to EN 62368-1.

**Installation of data lines**

The data cables must be completely protected and provide with metal or metallised connector housings. Shielded cables and connectors are necessary, in order to avoid radiant emittance and receipt of electrical disturbances.

**Allowable lines**

Shielded line:

4 x 2 x 0,14 mm<sup>2</sup> ( 4 x 2 x AWG 26)  
6 x 2 x 0,14 mm<sup>2</sup> ( 6 x 2 x AWG 26)  
12 x 2 x 0,14 mm<sup>2</sup> (12 x 2 x AWG 26)

Sending and receiving lines have to be twisted in pairs.

Maximum line length:

with interface V 24 (RS-232C) - 3 m (with shielding)  
with USB - 3 m  
with Ethernet - 100 m

**Air convection**

To avoid inadmissible heating, free air convection has to be ensured.

**Limit values**

Protection according IP: 20

Ambient temperature °C (operation): Min. +5 Max. +35

Ambient temperature °C (storage): Min. -20 Max. +60

Relative air humidity % (operation): Max. 80

Relative air humidity % (storage): Max. 80

(bedewing of printers not allowed)

**Guarantee**

We do not take any responsibility for damage caused by:

- Ignoring our operating conditions and operating manual.
- Incorrect electric installation of environment.
- Building alterations of our printers.
- Incorrect programming and operation.
- Not performed data protection.
- Using of not original spare parts and accessories.
- Natural wear and tear.

When (re)installing or programming our printers please control the new settings by test running and test printing. Herewith you avoid faulty results, reports and evaluation.

Only specially trained staff is allowed to operate the printers.

Control the correct handling of our products and repeat training.

We do not guarantee that all features described in this manual exist in all models. Caused by our efforts to continue further development and improvement, technical data might change without notice.

By further developments or regulations of the country illustrations and examples shown in the manual can be different from the delivered model.

Please pay attention to the information about admissible print media and the notes to the printer maintenance, in order to avoid damages or premature wear.

We endeavoured to write this manual in an understandable form to give you as much as possible information. If you have any queries or if you discover errors, please inform us to give us the possibility to correct and improve our manual.



### 3 Technical Data

	Vita V 103/8 T	Vita V 104/8	Vita V 106/12	Vita V 106/24	Vita V 108/12 T
Print resolution	203 dpi	203 dpi	300 dpi	600 dpi	300 dpi
Max. print speed	200 mm/s	200 mm/s	150 mm/s	100 mm/s	150 mm/s
Print width	104 mm	104 mm	105,7 mm	105,7 mm	108,4 mm
Passage width					
Standard	116 mm	116 mm	116 mm	116 mm	116 mm
Cutter mode	112 mm	112 mm	112 mm	112 mm	112 mm
Printhead	Flat Type <sup>1</sup>	Flat Type <sup>2</sup>	Flat Type <sup>2</sup>	Flat Type <sup>2</sup>	Flat Type <sup>1</sup>
<b>Labels</b>					
Labels, continuous rolls or fan-fold	paper, cardboard, textile, synthetics				
Max. material weight	220 g/m <sup>2</sup> (larger on demand)				
Min. label width	12 mm				
Min. label height	standard: 5 mm cutter/dispenser mode: 15 mm				
Max. label height	6000 mm	6000 mm	3000 mm	1000 mm	3000 mm
Max. roll diameter	internal unwinder: 180 mm internal rewinder: --				
Core diameter	40 mm / 75 mm (option)				
Winding	outside or inside				
Label sensor	transmission and reflexion from bottom				
<b>Transfer Ribbon</b>					
Ink	outside or inside				
Max. roll diameter	Ø 80 mm				
Core diameter	25,4 mm / 1"				
Max. ribbon length	450 m				
Max. width	110 mm				
<b>Dimensions (mm)</b>					
Width x height x depth	236 x 238 x 374				
Weight	11 kg				
<b>Electronics</b>					
Processor	TI Sitara ARM Cortex A8, 1GHz 32kB ICache, 32kB DCache up to 2000 Mips				
RAM	512 MB				
Slot	for SD card				
Battery cache	for Real-Time clock (storage of data with shut-down)				
Warning signal	acoustic signal when error				
<b>Interfaces</b>					
Serial	RS-232C (up to 115200 Baud)				
USB	2.0 High Speed Slave				
Ethernet	10/100 Base T, LPD, RawIP-Printing, DHCP, HTTP, FTP				
2 x USB Host	on the back for: keyboard, USB memory stick				
WLAN (option)	USB WLAN stick				
<b>Operation Data</b>					
Power supply	110 ... 230 V AC / 50-60 Hz				
Max. power consumption	275 VA				
Nominal current	2.5 A				
Operating temperature	5 ... 35 °C				
Humidity	max. 80 % (non-condensing)				

<sup>1</sup> for thermal direct

<sup>2</sup> for thermal transfer

Operation Panel	Vita V 103/8 T	Vita V 104/8	Vita V 106/12	Vita V 106/24	Vita V 108/12 T
Keys	test print, function menu, quantity, SD Card, feed, enter, 4 x cursor				
LCD display	graphic display 128 x 64 pixel				
<b>Settings</b>					
	date, time, shift times 20 language settings (others on demand) label and device parameters, interfaces, password protection, variables				
<b>Monitoring</b>					
Stop printing if	end of ribbon / end of labels / printhead open				
Status report	extensive status print with information about settings e.g. print length counter, runtime counter, photocell interface and network parameters printout of all internal fonts and all supported bar codes				
<b>Fonts</b>					
Font types	6 Bitmap fonts 8 Vector fonts/TrueType fonts 6 proportional fonts other fonts on demand				
Character sets	Windows 1250 up to 1257, DOS 437, 850, 852, 857, UTF-8 all West and East European Latin, Cyrillic, Greek and Arabic (option) characters are supported other character sets on demand				
Bitmap fonts	size in width and height 0,8 ... 5,6 zoom 2 ... 9 orientation 0°, 90°, 180°, 270°				
Vector fonts/TrueType fonts	size in width and height 1 ... 99 mm variable zoom orientation 0°, 90°, 180°, 270°				
Font attributes	depending on character font bold, Italic, Inverse, Vertical				
Font width	variable				
<b>Bar Codes</b>					
1D bar codes	CODABAR, Code 128, Code 2/5 interleaved, Code 39, Code 39 extended, Code 93, EAN 13, EAN 8, EAN ADD ON, GS1-128, Identcode, ITF 14, Leitcode, Pharmacode, PZN 7 Code, PZN 8 Code, UPC-A, UPC-E				
2D bar codes	Aztec Code, CODABLOCK F, DataMatrix, GS1 DataMatrix, MAXICODE, PDF 417, QR Code				
Composite bar codes	GS1 DataBar Expanded, GS1 DataBar Limited, GS1 DataBar Omnidirectional, GS1 DataBar Stacked, GS1 DataBar Stacked Omnidirectional, GS1 DataBar Truncated				
	all bar codes are variable in height, module width and ratio. orientation 0°, 90°, 180°, 270°. Optionally with check digit and human readable line.				
<b>Software</b>					
Configuration	ConfigTool				
Process control	NiceLabel				
Label software	Labelstar Office Lite, Labelstar Office				
Windows driver	Windows 7® - Windows 10® 32/64 Bit, Windows 11® Windows Server 2008® (R2) - Windows Server 2022®				



**Standard equipment**

- Tear-off edge
- Real time clock with printout date and time  
Automatic daylight saving time  
Storage of data with shut-down
- Variables: link field, counter, date/time, currency and shift variable, SD data
- Integrated unwinder  
(max. outer diameter 180 mm)
- Thermal and thermal transfer version
- Ethernet interface
- CVPL protocol and ZPL II® protocol
- Label photocell  
(transmission and reflexion from below)
- Slot for SD card

**Optional equipment**

- Cutting unit
- Dispenser unit with photocell
- Dispenser unit without photocell
- External rewinder for labels
- External rewinder for backing paper
- Unwinder
- USB-WLAN-Stick
- Dispenser I/O

### 3.1 Control Inputs and Outputs

By means of a maximum of 16 control inputs and outputs which, in the following, are also referred to as ports, different functions of the printer system can be triggered and operating states can be displayed.

The ports are provided by means of a D-Sub bushing (26pin HD) at the rear panel of the printer system and are galvanically isolated from protective earth (PE) by means of an optocoupler semi-conductor route.

Each port can be configured as input and as output. This function however, is predefined in the printer software and cannot be changed by the user.

The following parameters can be changed and set by using the menu: debounce times and high or low active.

#### Printer, internal circuitry

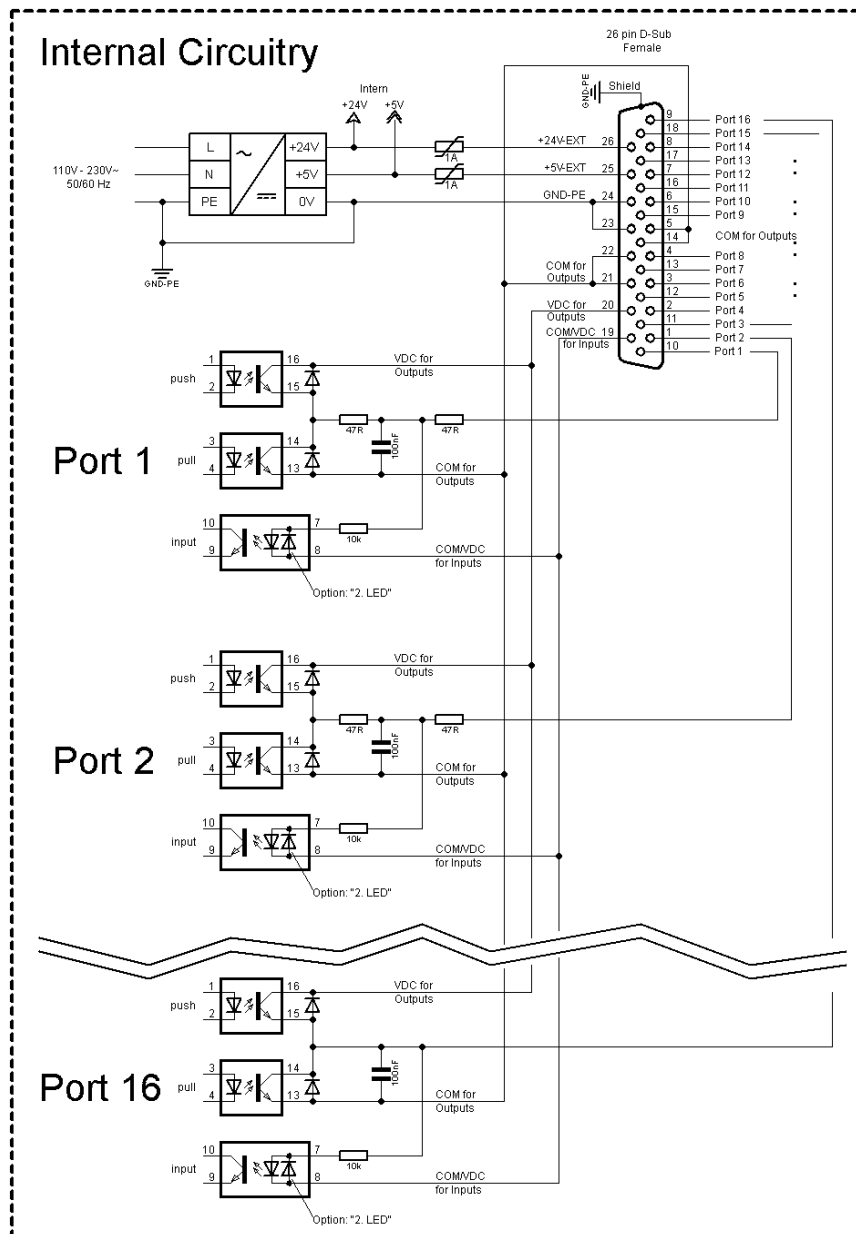
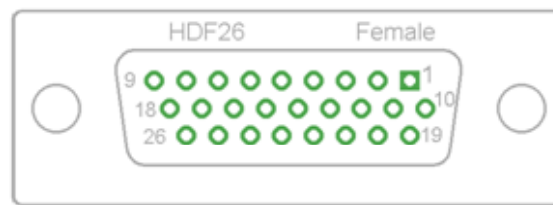

Figure 2

### Configuration of D-Sub socket



**Figure 3**

### Cable identification

Number	Color
1	white
2	brown
3	green
4	yellow
5	grey
6	pink
7	blue
8	red
9	black
10	violet
11	grey-pink
12	red-blue
13	white-green
14	brown-greed
15	white-yellow
16	yellow-brown
17	white-grey
18	grey-brown
19	white-pink
20	pink-brown
21	white-blue
22	brown-blue
23	white-red
24	brown-red
25	white-black
26	brown-black

Port 1 to Port 16 = Assignment for I/O Profile *Std\_Label*

Identification	Pin	Description / Function
Port 1	10	Print start and cut (Input)
Port 2	1	Reprint last printed label (Input)
Port 3	11	Counter Reset (Input)
Port 4	2	Option applicator only: Start application (Input)
Port 5	12	Error reset (Input)
Port 6	3	Cancel all print jobs (Input)
Port 7	13	No function
Port 8	4	No function
Port 9	15	Error (Output)
Port 10	6	Print order activ (Output)
Port 11	16	Dispenser photocell: Label exists at dispenser photocell (Output)
Port 12	7	Single print (Output)
Port 13	17	Ready (Output)
Port 14	8	Option applicator only: Ready for application (Output)
Port 15	18	Option scanner only: Bar code not readable (Output)
Port 16	9	Prior warning for transfer ribbon end (Output)
COM/VDC for Inputs	19	Common reference potential of all control inputs. 'COM/VDC for Inputs' is usually connected with the (-) terminal of the control voltage and the control inputs are switched to active (+). By means of the option '2nd LED', 'COM/VDC for Inputs' can optionally be connected with the (+) terminal of the control voltage. Then, the control inputs are switched to active (-).
VDC for Outputs	20	Common supply connection of all control outputs. 'VDC for Outputs' must be connected with the (+) terminal of the control voltage. Never leave 'VDC for Outputs' open even if no output is used.
COM for Outputs	5,14 21,22	Common reference potential of all control outputs. 'COM for Outputs' must be connected with the (-) terminal of the control voltage. Never leave 'COM for Outputs' open even if no output is used.
GND-PE	23,24	'GND-PE' is the reference potential of the '+5 VDC EXT' and '+24 VDC EXT' voltages provided by the printer system. 'GND-PE' is printer internally connected with protective earth (PE).
+ 5 VDC EXT	25	5 Volt DC output for external use. Max. 1 A. This voltage is provided from direct print module and can be used e.g. as control voltage. Never apply any external voltage to this output.
+ 24 VDC EXT	26	24 Volt DC output for external use. Max. 1 A. This voltage is provided from direct print module and can be used e.g. as control voltage. Never apply any external voltage to this output.

Port 1 to Port 16 = Assignment for I/O Profile *StdFileSelLabel*

Identification	Pin	Description / Function
Port 1	10	Print start and cut (Input)
Port 2	1	Error reset (Input)
Port 3	11	Number of the file to load Bit 0 (Input)
Port 4	2	Number of the file to load Bit 1 (Input)
Port 5	12	Number of the file to load 2 (Input)
Port 6	3	Number of the file to load 3 (Input)
Port 7	13	Number of the file to load 4 (Input)
Port 8	4	Number of the file to load 5 (Input)
Port 9	15	Error (Output)
Port 10	6	Print order active (Output)
Port 11	16	Dispenser photocell: Label exists at dispenser photocell (Output)
Port 12	7	Printing (Output)
Port 13	17	Ready (Output)
Port 14	8	No function
Port 15	18	Option scanner only: Bar code not readable (Output)
Port 16	9	Transfer ribbon prior warning (Output)

Port 1 to Port 16 = Assignment for I/O Profile *APL*

Identification	Pin	Description / Function
Port 1	10	Print start and cut (Input)
Port 2	1	Reprint last printed label (Input)
Port 3	11	Counter reset (Input)
Port 4	2	Option applicator only: Start application (Input)
Port 5	12	Error reset (Input)
Port 6	3	Cancel all print jobs (Input)
Port 7	13	No function
Port 8	4	No function
Port 9	15	Error (Output)
Port 10	6	Print order active (Output)
Port 11	16	Dispenser photocell: Label exists at dispenser photocell (Output)
Port 12	7	Printing (Output)
Port 13	17	Ready (Output)
Port 14	8	Option applicator only: Ready for application (Output)
Port 15	18	Option applicator only: Pad is in printing position (Output)
Port 16	9	Transfer ribbon prior warning (Output)

**Technical data**

Plug Connector	
Type	D-Sub connector High Density 26-pin. / connector
Manufacturer	W+P-Products
Reference number	110-26-2-1-20
Output Voltages (connected with GND-PE)	
+ 24 V / 1 A	Fuse: Polyswitch / 30 V / 1 A
+ 5 V / 1 A	Fuse: Polyswitch / 30 V / 1 A
Port 1 - 15	
<b>Input</b>	
Voltage	5 VDC ... 24 VDC
Impedance	47Ω + (100nF    10 kΩ)
<b>Output</b>	
Voltage	5 VDC ... 24 VDC
Impedance	47Ω + (100nF    10 kΩ    47Ω)
Current max.	High +15 mA Low -15 mA
Port 16	
<b>Input</b>	
Voltage	5 VDC ... 24 VDC
Impedance	100nF    10 kΩ
<b>Output</b>	
Voltage	5 VDC ... 24 VDC
Impedance	100nF    10 kΩ
Current max.	High +500 mA (Darlington BCP56-16) Low - 500 mA (Darlington BCP56-16)
Optocoupler	
Output	TCMT4106, CTR 100 % - 300 %, Vishay or TLP281-4(GB), CTR 100 % - 600 %, Toshiba
Input	TCMT4106, CTR 100 % - 300 %, Vishay or TLP281-4(GB), CTR 100 % - 600 %, Toshiba
Input Option 2nd LED	TCMT4600, CTR 80 % - 300 %, Vishay or TLP280-4, CTR 33 % - 300 %, Toshiba

**Example 1**

Device connection to a machine with S7-300 SPS.

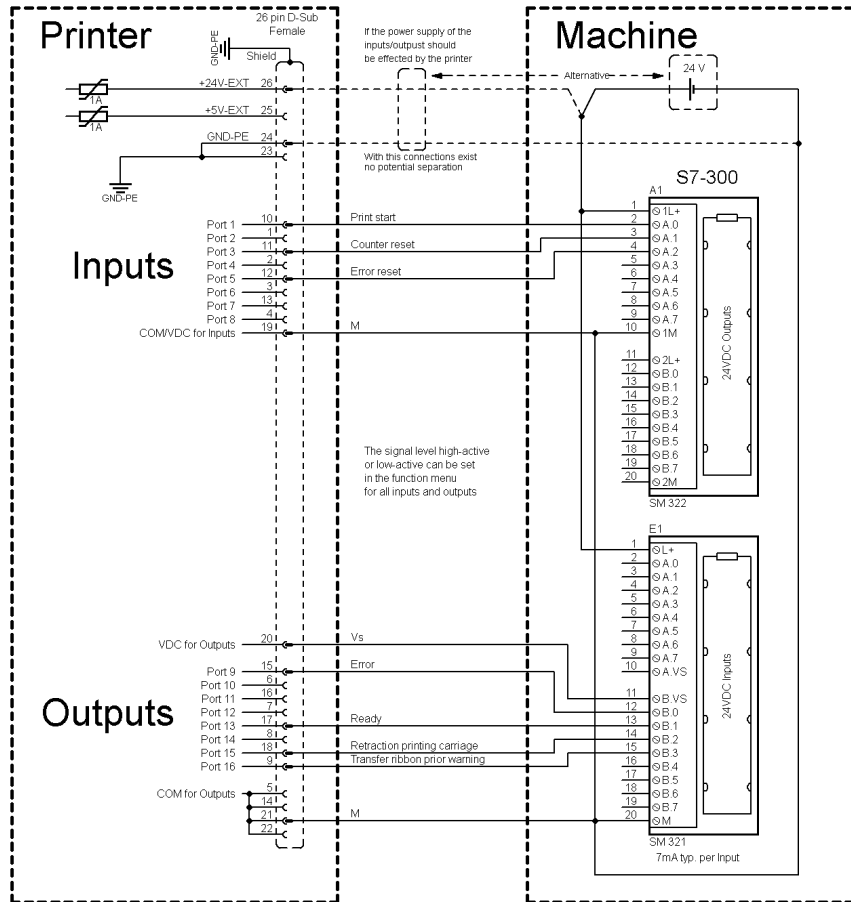

**Figure 4**

**Example 2**

Device connection to an operating panel.

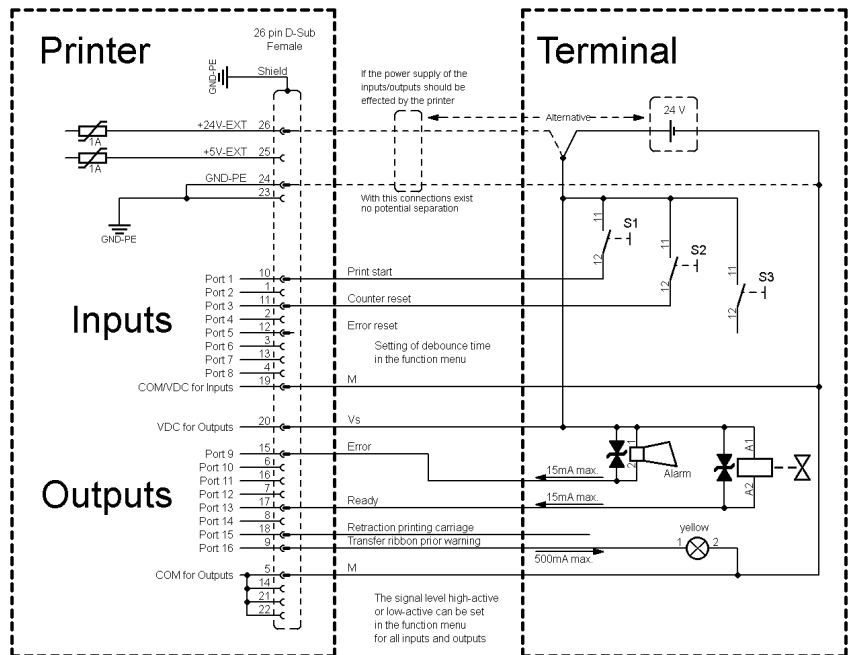

**Figure 5**

**Example 3**

Device connection version if 'Option: 2. LED'.

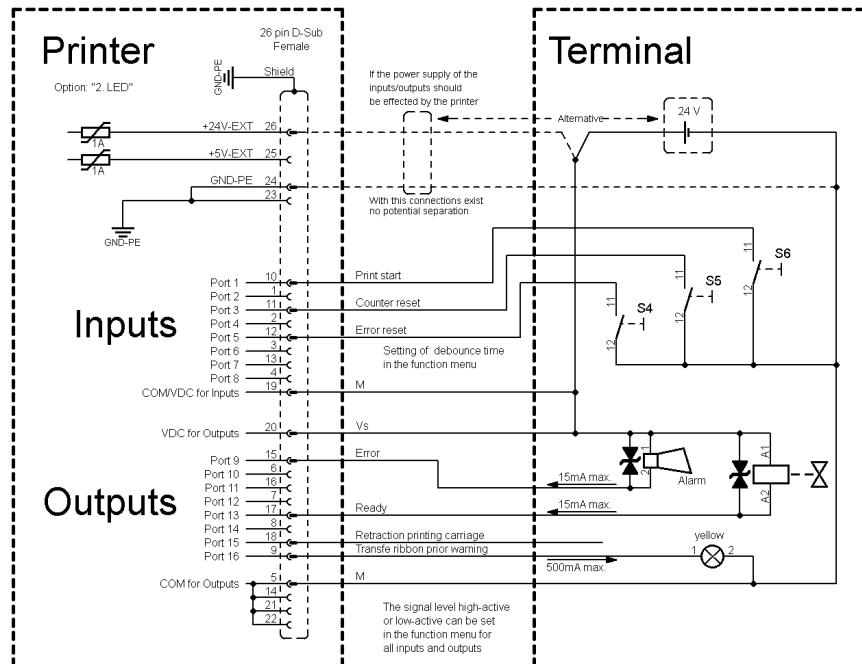

**Figure 6**

**Precautions**

When connecting a reed contact with a control input, the contact must have a switching capacity of min. 1 A in order to prevent the contact from sticking due to the inrush current. As an alternative, a suitable resistor can be connected in series.

If one of the printer's internal voltages '+5 VDC EXT' or '+24 VDC EXT' is used, an external fuse e.g. 0.5 AF, should be additionally installed to protect the printer electronics.

In the event of an inductive load, an antiparallel connected diode, for instance, must be used to discharge the induction energy.

In order to minimise the influence of leakage currents at control outputs, a resistor must, depending on what is connected, be installed in parallel with the load.

In order to avoid any damages to the printing system, the max. output currents must not be exceeded or outputs shorted.



## 4 Installation

### Unpack the label printer

- ⇒ Lift the label printer on the bottom and remove the printer from the carton.
- ⇒ Check the label printer for transport damages.
- ⇒ Check delivery for completeness.

### Scope of delivery

- Label printer.
- Power cable.
- Empty core, mounted on the transfer ribbon rewinder.
- Tear-off edge (basic printers only).
- Dispensing edge (printers with the option dispenser only).
- Cutter unit (printers with the option cutter only).
- Product Safety Guide.



#### **NOTICE!**

Retain the original packaging for subsequent transport.

### 4.1 Set up the Label Printer



#### **CAUTION!**

The label printer and the print media can be damaged by moisture and water.

- ⇒ Set up the label printer only in a dry place protected from sprayed water.
  
- ⇒ Set up the label printer on a level, vibration-free and air draught-free surface.
- ⇒ Open the cover of label printer.
- ⇒ Remove the foam transportation safeguards near the printhead.

## 4.2 Connect the Label Printer

### Connect to power supply

The label printer is equipped with a versatile power supply unit. The device may be operated with a mains voltage of 110 ... 230 V AC / 50-60 Hz without any adjustments or modifications.



#### CAUTION!

The label printer can be damaged by undefined switch-on currents.

- ⇒ Set the power switch to '0' before plugging in the label printer.
- ⇒ Insert the power cable into the power connection socket.
- ⇒ Insert the plug of power cable into a grounded electrical outlet.

### Connect to a computer or to a computer network



#### NOTICE!

Insufficient or missing grounding can cause faults during operation.  
Ensure that all computers and connection cables connected to the label printer are grounded.

- ⇒ Connect the label printer to a computer or network with a suitable cable.

## 4.3 Switch the Label Printer On and Off

After all connections are completed, switch on the label printer.

After switching on the label printer the main menu appears which shows the printer type, current date and time.

## 4.4 Initial Operation of the Label Printer

After switching on the label printer the main menu appears which shows the printer type, current date and time.

Insert label material and transfer ribbon (see chapter 5. Load Media, page 29).

Go to the menu *Label layout*, select menu item *Measure label* and start measuring (see chapter 6.4 Label Layout, page 43).

Press the key on CD ROM to finish measuring.



### NOTICE!

To enable correct measuring, at least two complete labels have to be passed through (not for continuous labels).

During measuring the label and the gap length small differences can occur. Therefore the values can be set manually in the menu *Label layout/Label and Gap*.



## 5 Load Media

### 5.1 Load Media



#### NOTICE!

As for the electrostatic unloading the thin coating of the thermal printhead or other electronic parts can be damaged, the label material should be antistatic. The use of wrong materials can lead to printer malfunctions and the guarantee can expire.

#### Load label roll in tear-off mode

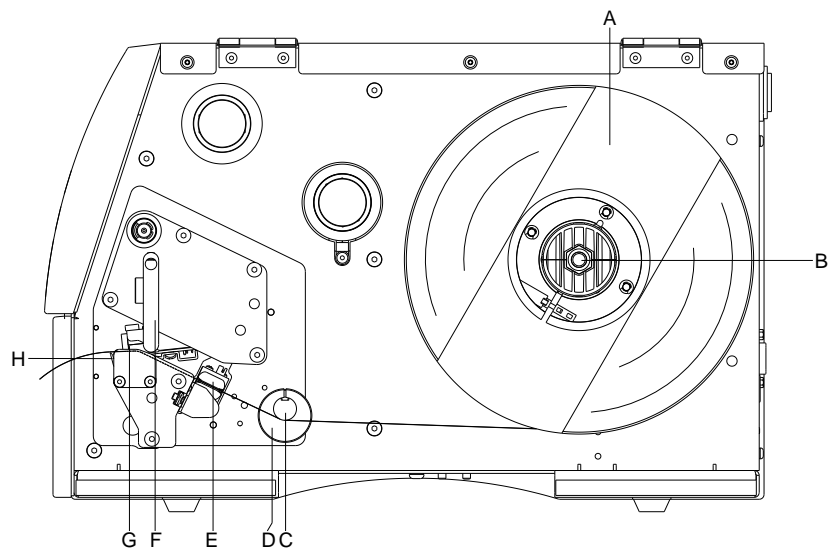

**Figure 7**

1. Open the printer cover.
2. Open the printhead (G) by turning the pressure lever (F) anticlockwise.
3. Remove the outside label mounting plate (A).
4. Load the label roll with inner winding onto the unwinding roll (B).
5. Attach again the label mounting plate (A).
6. Lead the label material below the return pulley (C) and the printhead (G).  
Pay attention that the label runs through the photocell (E).
7. In order to move the printhead (G) down, turn the pressure lever (F) in clockwise direction until it locks.
8. The tear off edge (H) is visible in front of the printhead.
9. Enter the offset value in the menu *Print settings/Tear-off*.
10. Adjust the adjusting ring (D) of the return pulley (C) to the width of material.
11. Close the printer cover.

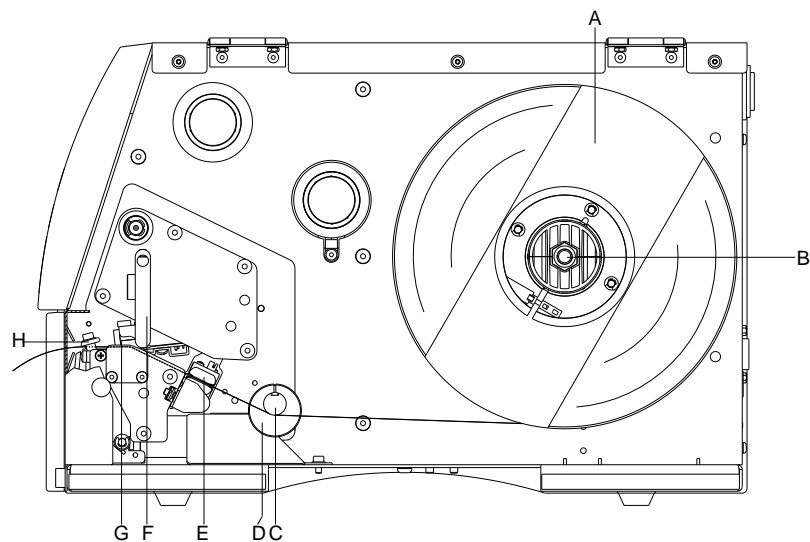
**Load label roll  
in cutter mode****Figure 8**

1. Open the printer cover.
2. Open the printhead (G) by turning the pressure lever (F) anticlockwise.
3. Remove the outside label mounting plate (A).
4. Load the label roll with inner winding onto the unwinding roll (B).
5. Attach again the label mounting plate (A).
6. Lead the label material below the return pulley (C) and the printhead (G).  
Pay attention that the label runs through the photocell (E).
7. Lead the label material through the cutter unit with integrated inserting angle (H).
8. In order to move the printhead (G) down, turn the pressure lever (F) in clockwise direction until it locks.
9. Adjust the adjusting ring (D) of the return pulley (C) to the width of material.
10. Close the printer cover.

### Load label in dispenser mode

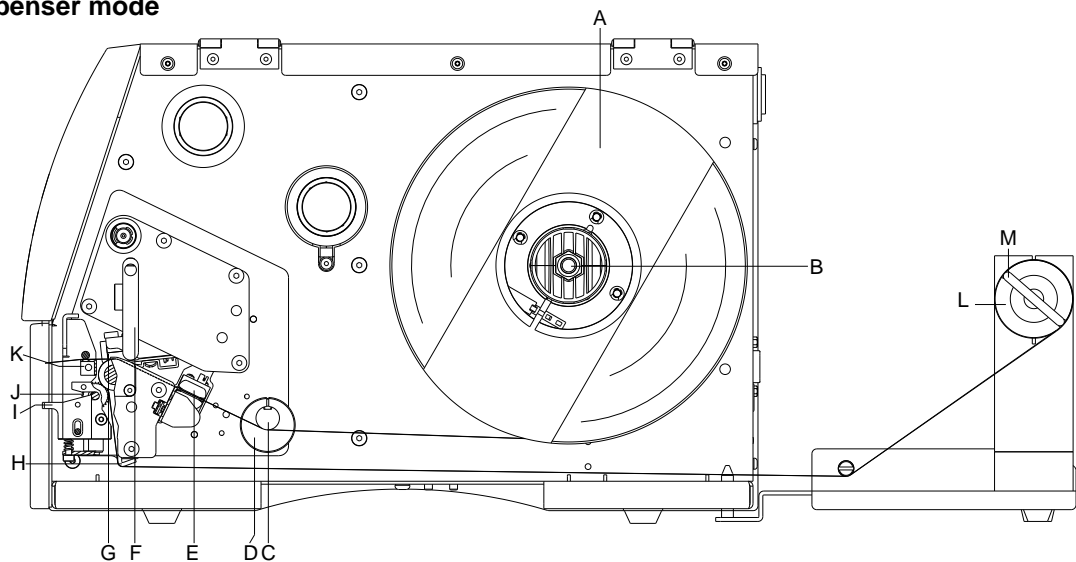

**Figure 9**

1. Open the printer cover.
2. Open the printhead (G) by turning the pressure lever (F) anticlockwise.
3. Remove the outside label mounting plate (A).
4. Load the label roll with inner winding onto the unwinding roll (B).
5. Attach again the label mounting plate (A).
6. Lead the label material below the return pulley (C) and printhead (G) and hold it towards the marked stopper surface (N).

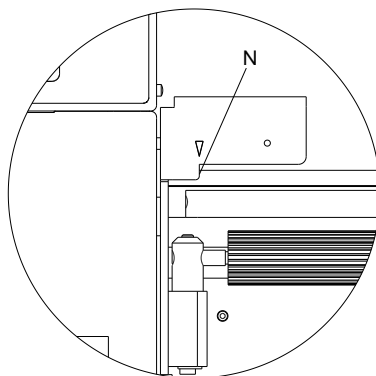

Pay attention that the label runs through the photocell (E).

7. In order to move the printhead (G) down, turn the pressure lever (F) in clockwise direction until it locks.
8. Adjust the adjusting ring (D) of the return pulley (C) to the width of material.

9. Press the key  to start a test print or release a measuring procedure (see chapter 6.4, page 43), to determine the exact position of the label beginning.
10. Unlock the dispensing roll (J) by pressing the locking part (I).
11. Strip some labels from the backing paper and lead the backing material over the dispensing whip (K).
12. Press the dispensing roll (J) backwards towards the backing paper.
13. Place the backing material under the dispensing angle (H) rearwards and fix it with the clamp (M) at the optional external rewinding unit (L).
14. Enter the offset value in *Dispenser I/O* menu.
15. Close the printer cover.



## 5.2 Load Fanfold Labels



### NOTICE!

As for the electrostatic unloading the thin coating of the thermal printhead or other electronic parts can be damaged, the label material should be antistatic. The use of wrong materials can lead to printer malfunctions and the guarantee can expire.

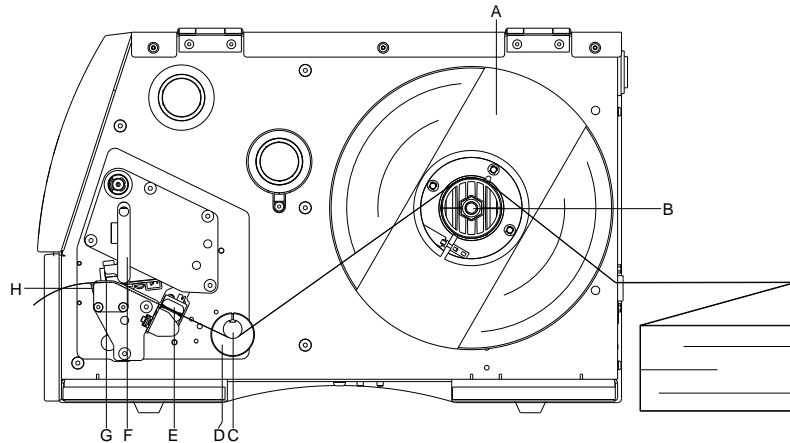

**Figure 10**

1. Open the printer cover.
2. Open the printhead (G) by turning the pressure lever (F) anticlockwise.
3. Load the fan-fold material from the back over the unwinding unit (B).
4. Lead the fan-fold material below the return pulley (C) and the printhead.  
Pay attention that the label runs through the photocell (E).
5. In order to move the printhead (G) down, turn the pressure lever (F) in clockwise direction until it locks.
6. Adjust the adjusting ring (D) of the return pulley (C) and the label mounting plate (A) to the width of material.
7. Close the printer cover.

### 5.3 Load Transfer Ribbon



#### NOTICE!

For the thermal transfer printing method it is necessary to load a ribbon, otherwise when using the printer in direct thermal print it is not necessary to load a ribbon. The ribbons used in the printer have to be at least the same width as the print media. In case the ribbon is narrower than the print media, the printhead is partly unprotected and this could lead to early wear and tear.

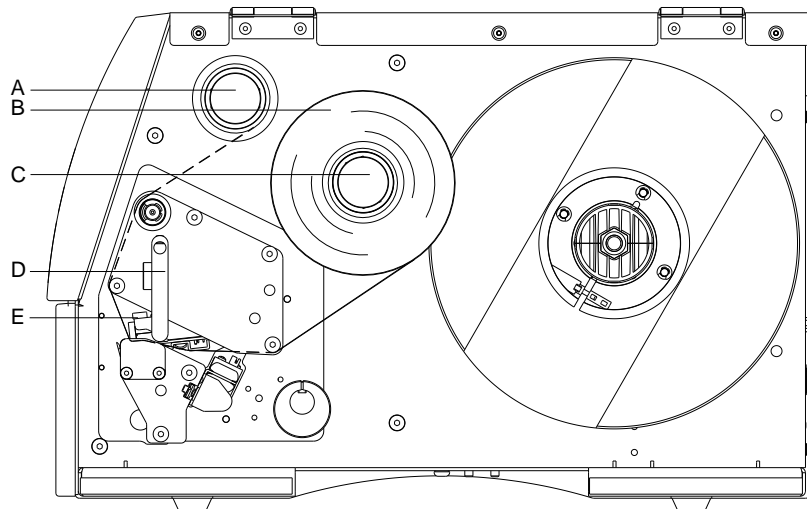

Figure 11



#### NOTICE!

Before a new transfer ribbon roll is loaded, the printhead must be cleaned using printhead and roller cleaner (97.20.002).

The handling instructions for the use of Isopropanol (IPA) must be observed. In the case of skin or eye contact, immediately wash off the fluid thoroughly with running water. If the irritation persists, consult a doctor.

Ensure good ventilation.

1. Open the printer cover.
2. Open the printhead (E) by turning the pressure lever (D) anticlockwise.



#### CAUTION!

Risk of scraping when inserting the transfer ribbon res. when removing the used transfer ribbon!

⇒ Be careful with the spring steel plate edges!

3. Load the transfer ribbon roll (B) with outer winding onto the unwinding roll (C).
4. Place an empty ribbon roll onto the rewinding roll (A) and lead the transfer ribbon below the printhead (E).

5. Fix the ribbon with an adhesive tape in rotating direction at the empty roll of the rewinding roll (A).  
Pay attention to the rotation direction of transfer ribbon rewinder anticlockwise.
6. In order to move the printhead (E) down, turn the pressure lever (D) in clockwise direction until it locks.
7. Close the printer cover.

**NOTICE!**

As for the electrostatic unloading the thin coating of the thermal printhead or other electronic parts can be damaged, the transfer ribbon should be antistatic. The use of wrong materials can lead to printer malfunctions and the guarantee can expire.

**CAUTION!**

Impact of electrostatic material on people!

- ⇒ Use antistatic transfer ribbon because electrostatic discharge can occur when removing.



## 6 Function Menu

### 6.1 Operation Panel

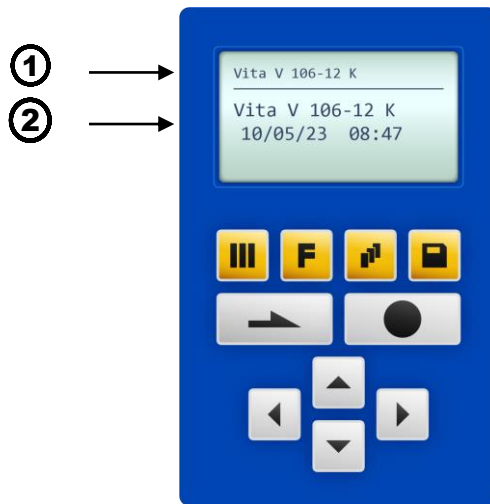

①	The top line of the graphic display shows the printer type.
②	The graphic display shows information about the current status of the printer and the print order, reports errors and shows the printer settings in the menus.
III	Back to the main menu. Start a test print. Delete a stopped print order.
F	Change to the function menu. In function menu: one menu item back.
Quantity key	Change to the quantity (number of pieces) menu. Press the keys ▲ and ▼ to select the number of labels that should be printed.
SD card key	Change to the menu of the SD card.
Left arrow key	Main menu: feed of one label. Function menu: skip to the next menu item.
Circle key	Confirm settings and modifications. Stop and continue the current print orders. Delete a stopped print order with the key III. No further label of the print order is printed.
Left arrow key	Return to the previous input field. Press the keys ▲ and ▼ to change the values.
Right arrow key	Skip to the next input field. Press the keys ▲ and ▼ to change the values.
Up arrow key	Increase the figure at the cursor position.
Down arrow key	Decrease the figure at the cursor position.

## 6.2 Menu Structure

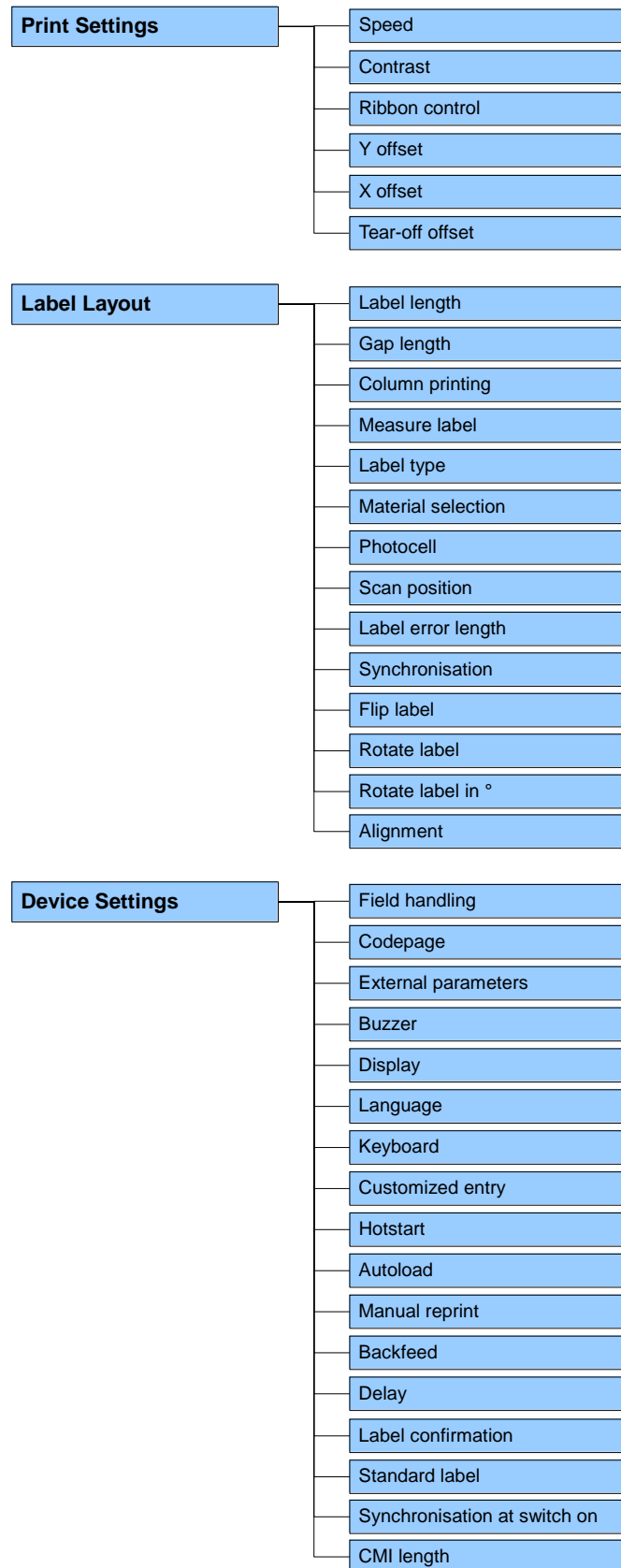

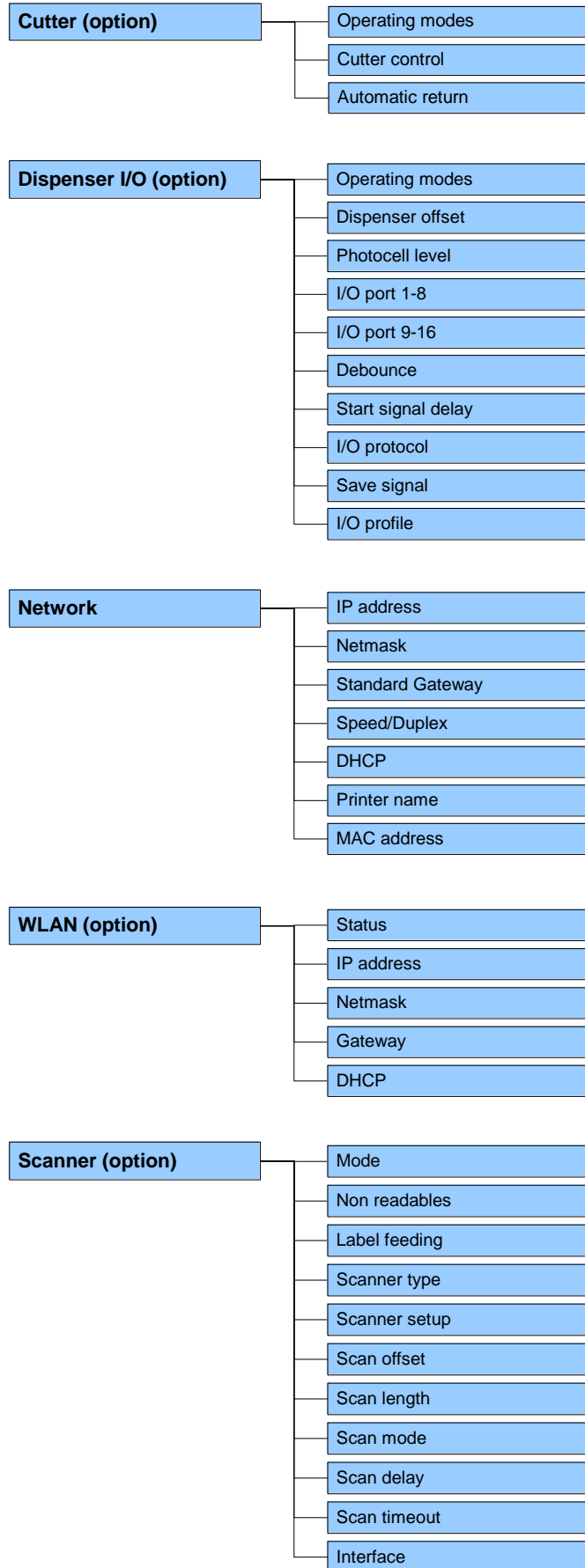

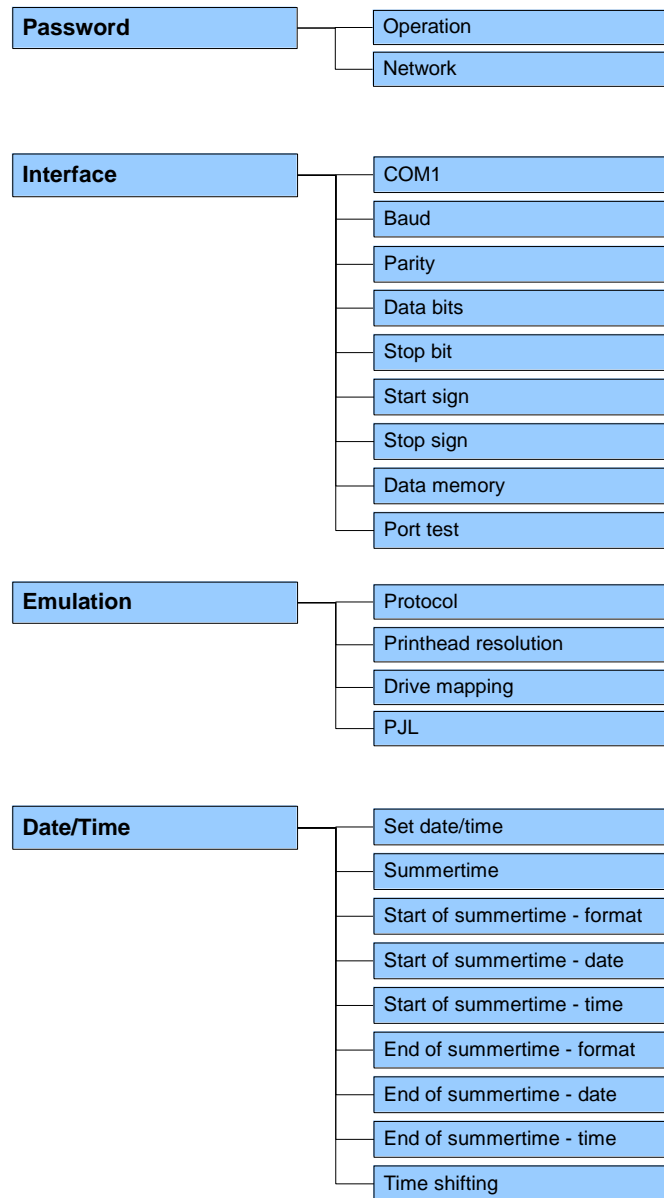



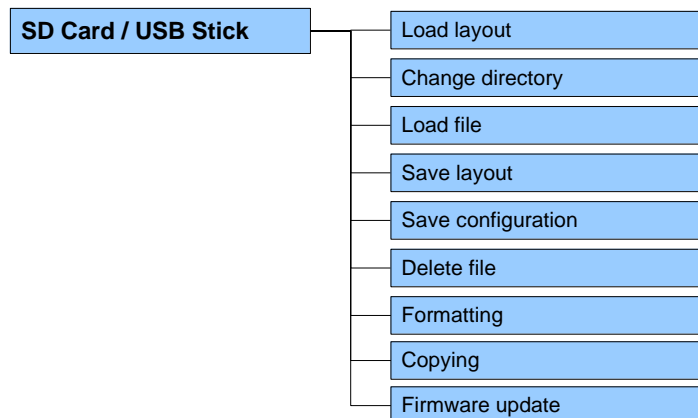
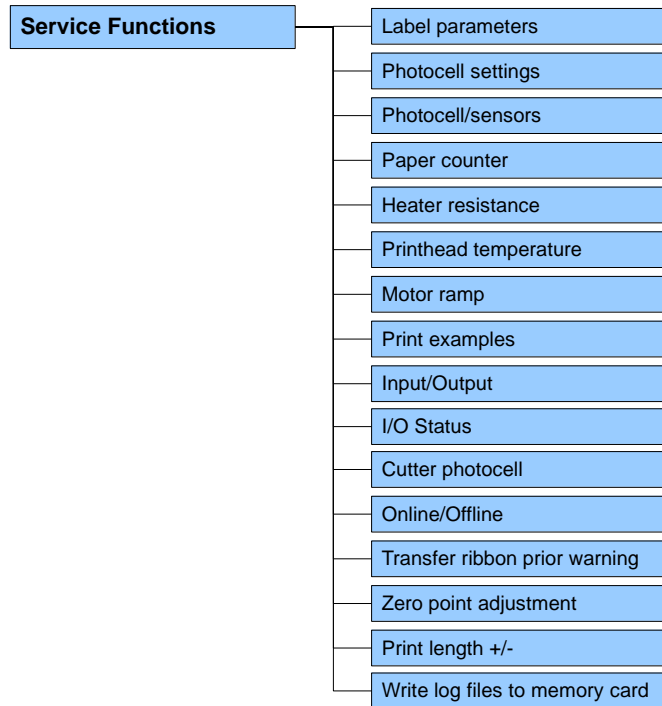

### 6.3 Print Settings

Switch on the label printer and the display shows the main menu.

Press the key **F** to access the function menu.

Press the key  to select the menu *Print settings*.

#### Speed

Indication of print speed in mm/s (see chapter Technical Data, page 15). The print speed can be determined for each print order anew. The setting of print speed affects also the test prints.

#### Contrast

Indication of value to set the print intensity when using different materials, print speeds or printing contents.

Value range: 10 % ... 200 %.

Step size: 10 %.

Press the key  to move to the next menu item.

#### Ribbon control

Examination if the transfer ribbon roll is to end or if the ribbon was torn at the unwinding roll. The current print order is interrupted and an Error Message appears at the printer display.

**Off:** The ribbon control is deselected, i.e. the printer continues without an error message.

**On, weak sensibility (default=:** The printer reacts at approx. 1/3 more slowly to the end of the transfer ribbon.

**On, strong sensibility:** The printer reacts immediately to the end of the transfer ribbon.

Press the key  to move to the next menu item.

#### Y displacement

Indication of initial point displacement in mm.

Displacement of the complete print in paper direction. With positive values the print in paper direction starts later.

Value range: -30.0 ... +90.0.

Press the key  to move to the next menu item.

#### X displacement

Displacement of the complete print transverse to the paper direction.

The displacement is possible only up to the edges of the printing zone and is determined by the width of the focal line in printhead.

Value range: -90.0 ... +90.0.

Press the key  to move to the next menu item.

#### Tear-off

Indication of value to which the last label of a print order is moved forward and is moved back to the beginning of label at a new print start. Labels can be torn off after terminating the print order without a label loss by tearing up.

Default value: 12 mm.

Value range: 0 ... 50.0 mm.







## 6.4 Label Layout







Switch on the label printer and the display shows the main menu.

Press the key **F** to access the function menu.

Press the key  until the menu *Label layout* is displayed.

Press the key  to select the menu.

<b>Label length</b>	Indication of label length in mm (see chapter Technical Data, page 15).
<b>Gap length</b>	Indication of distance between two labels in mm (not for continuous labels). Minimum value: 1 mm.  Press the key  to move to the next menu item.
<b>Column printing</b>	Indication of width of one label as well as how many labels are placed side by side (see chapter 11.1 Column Printing, page 99).  Press the key  to move to the next menu item.
<b>Measure label</b>	Press the key  to start measuring. The printer stops automatically after termination of measuring. The determined values are displayed and saved.  Press the key  to move to the next menu item.
<b>Label type</b>	Generally adhesive labels are set. Press the key  to select continuous labels. If the menu item <i>Label length/Gap length</i> contains a gap value, this value is added to the label length..  Press the key  to move to the next menu item.
<b>Material selection</b>	Selection of the used label and transfer ribbon material.  Press the key  to move to the next menu item.
<b>Photocell</b>	Selection of the used photocell. The selection of one of the following photocell types is possible: transmission photocell normal and inverse, reflexion photocell normal and inverse (see chapter 11.4 Photocells, page 104).
<b>Scan position (AP)</b>	Entry of percental label length by that the label end is searched. Marks onto the label can be skipped.

	Press the key  to move to the next menu item.
<b>Label error length</b>	In case an error occurs, indication after how many mm a message appears in the display. Value range:1 mm ... 999 mm.
<b>Synchronization</b>	<b>On:</b> If a label is missed on the liner an error message is displayed. <b>Off:</b> Missing labels are ignored, i.e. it is printed into the gap.  Press the key  to move to the next menu item.
<b>Flip label</b>	The axis of reflection is in the middle of the layout. If the label width was not transferred to the printer, automatically the default label width i.e. the width of the printhead is used. It is recommended to use labels with the same width as the printhead. Otherwise this can cause problems in positioning.  Press the key  to move to the next menu item.
<b>Rotate label</b>	According to standard the label is printed ahead with a rotation of 0°. If the function is activated, the label is rotated by 180° and printed in reading direction.  Press the key  to move to the next menu item.
<b>Rotate label (in °)</b>	Corresponding to the parameter <i>Rotate label</i> , the label can be turned in 90° steps.   <b>NOTICE!</b> Only printer internal objects (text, lines and barcodes) can be turned. The rotation of graphics is not possible.  Press the key  to move to the next menu item.
<b>Alignment</b>	The adjustment of label is effected only after <i>Flip/Rotate label</i> , i.e. the adjustment is independent of the functions <i>Flip label</i> and <i>Rotate label</i> . <b>Left:</b> The label is aligned at the left-most position of printhead. <b>Centre:</b> The label is aligned at central point of printhead. <b>Right:</b> The label is aligned at right-most position of printhead.

## 6.5 Device Settings

Switch on the label printer and the display shows the main menu.

Press the key **F** to access the function menu.

Press the key  until the menu *Device settings* is displayed.

Press the key  to select the menu.

### Field handling

**Off:** The complete print memory is deleted.

**Keep graphic:** A graphic res. a TrueType font is transferred to the printer once and stored in the printer internal memory. For the following print order only the modified data is transferred to the printer. The advantage is the saving of transmitting time for the graphic data. The graphic data created by the printer itself (internal fonts, bar codes, ...) is generated only if they were changed. The generating time is saved.

**Delete graphic:** The graphics res. TrueType fonts stored in the printer-internal memory is deleted but the other fields are kept.

**Restore graphic:** At the end of the print order the printed order can again be started at the printer. All graphics and TrueType fonts are again printed.



#### NOTICE!

**Exception:** With column printing always full columns must be printed (number of pieces always multiple of the columns). Deleted columns are not restored.

Press the key  to move to the next menu item.

### Codepage

Indication of the font used in the printer. The following possibilities are available:

Codepage 1252 West European (former ANSI)

Codepage 437 English

Codepage 850 Western European

Codepage 852 Slavic

Codepage 857 Turkish

Codepage 1250 Central and East European

Codepage 1251 Cyrillic







Codepage 1253 Greek

Codepage 1254 Turkish

Codepage 1257 Baltic

WGL4

Please find the tables referring to the above mentioned character sets on [www.carl-valentin.de/Downloads](http://www.carl-valentin.de/Downloads).

- Press the key  to move to the next menu item.
- External parameters**      **Label dimension only:** The parameters for label length, gap length and label width can be transferred to the printer. All other parameter settings are to be made directly at the printer.  
**On:** Sending parameters such as print speed and contrast via our label creation software to the printer. Parameters which are set directly at the printer before are no longer considered.  
**Off:** Only settings made directly at the printer are considered.
- Press the key  to move to the next menu item.
- Buzzer**      **On:** An acoustic signal is audible when pressing a key.  
Value range: 35 ... 85  
**Off:** No signal is audible.
- Display**      Setting of display contrast.  
Value range: 45 ... 75.
- Press the key  to move to the next menu item.
- Printer language**      Selection of language in which you want to display the text in the printer display.  
At the moment the following languages are available: German, English, French, Spanish, Portuguese, Dutch, Italian, Danish, Finnish, Polish, Czech, Hungarian, Russian, Chinese (option), Ukrainian, Estonian.
- Press the key  to move to the next menu item.
- Keyboard layout**      Selection of region for the desired keyboard layout. The following possibilities are available: German, English, French, Greek, Spanish, Swedish, US American, Russian.
- Press the key  to move to the next menu item.
- Customized entry**      **Off:** No question appears at the display. In this case the stored default value is printed.  
**On:** The question referring the customized variable appears once before the print start at the display.  
**Auto:** The questions referring the customized variable and the quantity query appear after every printed layout.  
**Auto without quantity query:** The question referring the customized variable appears after every layout without additional query for the quantity.
- Press the key  to move to the next menu item.
- Hotstart**      **On:** Continue an interrupted print order after switching on the printer anew.  
**Off:** After switching off the printer the complete data is lost (see chapter 11.2 Hotstart, page 100).

Press the key  to move to the next menu item.

### Autoload

**On:** A label which was loaded once from SD card can be loaded again automatically after a restart of printer.

**Procedure:** The used label is saved onto SD card. The label is loaded from SD card and printed. After switching the printer Off and again On, the label is loaded from SD card automatically and can be printed again.

Press the key  to start printing with input of number of labels.



#### NOTICE!

The last loaded label from SD card is always again loaded after a restart of printer.

**Off:** After a restart of printer the last used label must be again loaded manually from SD card.





#### NOTICE!

A common use of the functions Autoload and Hotstart is not possible. For a correct Autoload procedure the Hotstart must be deactivated in the printer.

Press the key  to move to the next menu item.

### Manual reprint

**Yes:** In case an error occurred and printer is in stopped mode then you can reprint the last printed labels by means of the keys  and .

**No:** Only blank labels were advanced.

Press the key  to move to the next menu item.

### Backfeed

The backfeed was optimised in the operating modes dispenser (optional) and cutter (optional). Now, when driving into the offset, the following label is 'pre-printed' if possible and therefore the backfeed of label is no necessary and time can be saved.

### Delay

The adjustable deceleration time is only for mode 'backfeed automatic' of importance (see chapter 11.3 Backfeed/Delay, page 102).

Press the key  to move to the next menu item.

### Label confirmation

**On:** A new print order is only printed after confirmation at the device. An already active continuing print order is printed as long as the confirmation is effected at the device.

**Off:** No query appears at the display of control unit.

Press the key  to move to the next menu item.

### Standard label

**On:** If a print order is started without previous definition of label, the standard label is printed.

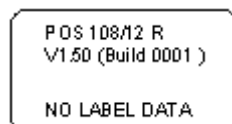

**Off:** If a print order is started without previous definition of label, an error message appears in the display.

**Synchronization at print start**

Press the key  to move to the next menu item.

**Off:** The synchronization is disabled, i.e. the measuring and label feed have to be released manually.

**Measure:** After switching on the printer, the loaded label is automatically measured.

**Feed:** After switching on the printer the label is synchronized to the beginning of label. For this one or multiple labels are advanced.

Press the key  to move to the next menu item.

**CMI length**

If the print is interrupted in the label, at the printhead this could lead to a small interruption in the printout, showing a fine white line onto the label. To avoid this, a value for the minimum backfeed can be set (0 – 1 mm) at which the label material is moved backwards. At the next print start the free range is overprinted. The setting of CMI length has only an influence at the selection of backfeed mode 'optimised backfeed'.

## 6.6 Network

Switch on the label printer and the display shows the main menu.

Press the key  to access the function menu.

Press the key  until the menu *Network* is displayed.

Press the key  to select the menu.

For more information, please see the separate manual.



## 6.7 Password

Switch on the label printer and the display shows the main menu.

Press the key **F** to access the function menu.





Press the key  until the menu *Password* is displayed.

Press the key  to select the menu.

With a password different functions can be blocked for the operator. There are different applications with which such a password protection can be used reasonably. To receive a most flexible password protection, the printer functions will be divided into several function groups.

Because of these different function groups the password protection is very flexible. The printer can be adjusted best to its actual order, as only certain functions are blocked.

### Operation

<b>Password</b>	<p>Entering a 4-digit numeric password.</p> <p>Press the key  to move to the next menu item.</p>
<b>Protection configuration</b>	<p>Printer settings can be changed (contrast, speed, operating mode, ...). The password protection prevents modifications at the printer settings.</p> <p>Press the key  to move to the next menu item.</p>
<b>Protection favorites</b>	<p>The password protection prevents the access to the favorites.</p> <p>Press the key  to move to the next menu item.</p>
<b>Protection memory card</b>	<p>With the functions of the memory card, labels can be stored, loaded, etc. The password protection has to decide if no access or only readable access on SD card is allowed.</p> <p><b>No protection:</b> No password protection  <b>Userview only:</b> Only reading access  <b>Protected:</b> Access blocked</p> <p>Press the key  to move to the next menu item.</p>
<b>Protection Printing</b>	<p>In case the printer is connected to a PC, it can be useful, that the user is not able to produce a print manually. So the password protection prevents that prints can be produced manually.</p> <p>Press the key  to move to the next menu item.</p> <p>In order to execute a blocked function, first of all the valid password has to be entered. If the correct password is entered then the desired function can be executed.</p>

## Network

### Password

Entering a 15-digit password. The password can consists of alphanumeric and special characters.

Press the key  to move to the next menu item.

### Protection HTTP

The communication by HTTP can be avoided.

Press the key  to move to the next menu item.

### Protection Telnet

The settings of the Telnet service cannot be changed.

Press the key  to move to the next menu item.

### Protection remote access

The password protection prevents the remote control of the printer.

Press the key  to move to the next menu item.

In order to execute a blocked function, first of all the valid password has to be entered. If the correct password is entered then the desired function can be executed.

## 6.8 Interface

Switch on the label printer and the display shows the main menu.

Press the key **F** to access the function menu.

Press the key  until the menu *Interface* is displayed.

Press the key  to select the menu.

### COM1 / Baud / P / D / S

#### COM1:

0 - serial interface Off.

1 - serial interface On.

2 - serial Interface On, no error message occurs in case of a transmission error.

#### Baud:

Indication of bits which are transferred per second (speed of data transfer).

Value range: 1200, 2400, 4800, 9600, 19200, 38400, 57600 and 115200.

#### P = Parity:

N - No parity; E - Even; O - Odd

Please observe that the settings correspond to those of the printer.

#### D = Data bits:

Setting of data bits. Value range: 7 or 8 Bits.

#### S = Stop bits:

Indication of stop bits between bytes.

Value range: 1 or 2 stop bits.

Press the key  to move to the next menu item.

### Start sign / End sign

**SOH:** Start of data transfer block → Hex format 01

**ETB:** End of data transfer block → Hex format 17

Two different start / end signs can be set. The settings are normally SOH = 01 HEX and ETB = 17 HEX. Several host computers cannot process these signs and therefore SOH = 5E HEX and ETB = 5F cannot be set.

Press the key  to move to the next menu item.

### Data memory

**Standard:** After starting a print order the printer buffer receives data as long as it is filled.



**Advanced:** During a current print order data is received and processed.

**Off:** After starting a print order no more data is received.

Press the key  to move to the next menu item.

### Port test

Check whether the data are transferred via the interface.

Press the keys  and  to select standard (On). Press the key  and the data sent via any port (COM1, LPT, TCP/IP) is printed.

## 6.9 Emulation

Switch on the label printer and the display shows the main menu.

Press the key  to access the function menu.

Press the key  until the menu *Emulation* is displayed.

Press the key  to select the menu.

### Protocol

**CVPL:** Carl Valentin Programming Language

**ZPL:** Zebra® Programming Language

Change between CVPL protocol and ZPL II® protocol.

Press the key  to confirm the selection.

The printer performs a restart and ZPL II® commands are transformed into CVPL commands internally by the printer and then executed by the printer.

In menu Protocol, press the key  to move to the next menu item.

### Printhead resolution

At activated ZPL II® emulation the printhead resolution of the emulated printer must be set, e.g. 11.8 Dot/mm (= 300 dpi).



#### NOTICE!

If the printhead resolution of the Zebra® printer differs from that of the Valentin printer, then the size of objects (e.g. texts, graphics) complies not exactly.

Press the key  to move to the next menu item.

### Drive mapping

The access to Zebra® drives

**B:** SD card

**E:** Flash drive

**R:** RAM disk (standard drive, if not indicated)

is rerouted to the corresponding Valentin drives

**A:** SD

**R:** RAM disk

**U:** not occupied

This can be necessary if the available space on the RAM disk (at present. 512 KByte) is not sufficient or if bitmap fonts are downloaded to the printer and be stored permanently.



#### NOTICE!

As the printer build-in fonts in Zebra® printers are not available in Valentin printers, this can cause small differences in the text image.

Press the key  to move to the next menu item.

### PJL (Printer Job Language)

The processing of PJL commands (Hewlett Packard® Print Job Language) can be switched On/Off. Status information relating to the print order can be queried.

## 6.10 Date & Time





Switch on the label printer and the display shows the main menu.

Press the key  to access the function menu.

Press the key  until the menu *Date/Time* is displayed.

Press the key  to select the menu.

### Setting of date and time

The upper line of display shows the current date, the second line the current time. Press the keys  to  arrive the next input field. Press the keys  and  to increase and/or decrease the figures at the cursor position.

Press the key  to move to the next menu item.

### Summertime

**On:** Printer automatically adjust clock for daylight saving changes.

**Off:** Summertime is not automatically recognized and adjusted.

Press the key  to move to the next menu item.

### Start of summertime – Format

Select the format in which you want to define beginning summertime. The above example indicates the default setting (European format).

DD = day      WW = week      WD = weekday  
MM = month    YY = year      next day = only next day is taken  
into consideration

Press the key  to move to the next menu item.

### Start of summertime – Date

By means of this function you can enter the date at which summertime has to start. This entry refers to the previously selected format. Example: summertime is automatically adjusted at last Sunday in March (03).

Press the key  to move to the next menu item.

### Start of summertime – Time

By means of this function you can define the time when you want to start summertime.

Press the key  to move to the next menu item.

### End of summertime – Format

Select the format in which you want to define end of summertime. The example above indicates the default setting (European format).

Press the key  to move to the next menu item.

### End of summertime – Date

By means of this function you can define the date when you want to stop summertime. The entry refers to the previously selected format. Example: summertime is automatically adjusted at last Sunday in October (10).

Press the key  to move to the next menu item.

### End of summertime – Time

By means of this function you can define the time when you want to stop summertime.

Press the key  to move to the next menu item.

### Time shifting

By means of this function you can enter time shifting in hours and minutes (for automatically adjustment from summer and wintertime). This entry refers to the currently set printer time.

## 6.11 Service Functions



### NOTICE!

So that the distributor res. the printer manufacturer in case of service can offer fast support, the printer is equipped with the menu *Service functions*.

Necessary information such as selected parameters can be taken directly from the printer. More details such as version of firmware or font are shown from the *Main menu*.

Switch on the label printer and the display shows the main menu.

Press the key **F** to access the function menu.

Press the key  until the menu *Service functions* is displayed.

Press the key  to select the menu.

### Label parameters

Indication of label parameters in Volt.

**A:** Indication of minimum value.

**B:** Indication of maximum value.

**C:** Indication of trigger level. The value is ascertained while measuring and can be changed.

Press the key  to move to the next menu item.

### Photocell configuration

This function enables definition of photocell levels.

In case of problems while positioning or measuring of label, levels for label photocell can be set manually. Make sure that a large hub as possible (above the label >3 V, above the gap <1 V) is set.

Press the key  to move to the next menu item.

### Photocell parameters

**DLS:** Indication of transmission photocell level in Volt.

**RLS:** Indication of reflexion photocell level in Volt.

**SLS:** Indication of peel off photocell level in Volt.

**TR:** Indication of transfer ribbon photocell status (either 0 or 1).

**H:** Indication of printhead position.

0 = printhead down

1 = printhead up

Press the key  to move to the next menu item.

### Paper counter







**D:** Indication of printhead attainment in meters.





**G:** Indication of printer attainment in meters.

Press the key  to move to the next menu item.

### Heater resistance

To achieve a high print quality, the indicated Ohm value must be set after replacing the printhead.

- Press the key  to move to the next menu item.
- Printhead temperature** Indication of printhead temperature. The printhead temperature corresponds normally to the room temperature. In case the maximum printhead temperature is exceeded, the current print order is interrupted and an error message appears at the printer display.
- Press the key  to move to the next menu item.
- Motor Ramp** This function is often used for high printing speed as the tearing of transfer ribbon can be prevented.  
The higher the '++' value is set, the slower the feeding motor is accelerated.  
The smaller the '--' value is set, the faster the feeding motor is decelerated.
- Press the key  to move to the next menu item.
- Print examples** **Settings:** Printout of all printer settings such as speed, label and transfer ribbon material.  
**Bar codes:** Printout of all available bar code types.  
**Fonts:** Printout of all available font types.
- Press the key  to move to the next menu item.
- Input** Indication of input signal level which depends on the set *I/O Profile* (see page 63).  
0 = Low  
1 = High
- Press the key  to move to the next menu item.
- Output** Indication of signal level which depends on the set *I/O Profile* (see page 63).  
0 = Low  
1 = High
- Press the key  to move to the next menu item.
- I/O Status** Relevant results are counted and registered in RAM memory. The protocols get lost after switching off the device.
- RInt** = Real Interrupts  
The start input impulses are counted directly at the Interrupt.
- Dbnc** = Debounced  
The start input impulses that are longer than the set debounce time are counted. Only these start impulses can lead to a print. If a start impulse is too short, no print is released. This is recognized by the fact that RInt is counted, Dbnc not.
- NPrn** = Not Printed  
The debounced start input impulses that have not lead to a print are counted. Causes: no active print order, print order stopped (manually or because of an error) or the printing system is still active with the processing of a print order.
- PrtStrtReset** = The counters are reset.
- PrtStrtTime** = Measured length of the last start impulse in ms.

	Press the key  to move to the next menu item.
<b>Cutter photocell</b>	1 – Printer is equipped with a cutter 2 – Printer is not equipped with a cutter
<b>Cutter Home</b>	1 – The cutter is in the initial position and ready for the cutting procedure. 0 – The cutter is not in the initial position. Before you are going to release a cutting procedure you first have to place the cutter in its initial position.
	Press the key  to move to the next menu item.
<b>Online / Offline</b>	This function is activated e.g. if the transfer ribbon is to be changed. It is avoided that a print order is processed although the module is not ready. If the function is activated then press the key  to change between Online and Offline mode. The respective state is indicated in the display. Standard: Off  <b>Online:</b> Data can be received by interface. The keys of the foil keyboard are only active, if you changed in the Offline mode with the key  . <b>Offline:</b> The keys of the foil keyboard are still active but received data are not processed. If the module is again in Online mode then new print orders can be again received.
	Press the key  to move to the next menu item.
<b>Transfer ribbon advance warning</b>	Before the end of transfer ribbon, a signal is send by the control output.
<b>Warning diameter</b>	Setting of transfer ribbon advance warning diameter.  In case you enter a value in mm then a signal appears via control output when reaching this diameter (measured at transfer ribbon roll).
<b>Ribbon advance warning mode</b>	<b>Warning:</b> When reaching the transfer ribbon advance warning diameter, the corresponding I/O output is set. <b>Reduced print speed:</b> Speed on which the printing speed is to be reduced. <b>Error:</b> The printing system stops when reaching the transfer ribbon advance warning diameter with the message 'too less ribbon'.
<b>Reduced print speed</b>	Setting of the reduced print speed in mm/s. This can be set in the limits of the normal print speed.



**Zero point adjustment  
in Y direction**

Press the key  to move to the next menu item.

Indication of value in 1/100 mm.

After replacing the printhead - the print cannot be continued at the same position on the label, the difference can be corrected in printing direction.

**NOTICE!**

The value for zero point adjustment is set ex works. After replacing the printhead, only service personnel are allowed to set this value anew.

**Zero point adjustment  
in X direction**

Press the key  to move to the next menu item.

Indication of value in 1/100 mm.

After replacing the printhead - the print cannot be continued at the same position on the label, the difference can be corrected across the printing direction.

**NOTICE!**

The value for zero point adjustment is set ex works. After replacing the printhead, only service personnel are allowed to set this value anew.

**Print length +/-**

Press the key  to move to the next menu item.

Indication of print layout correction in percent.

By mechanical influences (e.g. label roll size) the print layout can be printed increased and reduced to its original size.

Value range: +10.0 % ... -10.0 %

**Write log files to  
memory card**

Press the key  to move to the next menu item.

The printer logs different events internally. In case of service, the error cause can be located faster.

With this command, different log files are saved on an existing storage medium (memory card). After the 'Finish' message the storage medium can be removed.

The files are in directory 'log':

**LogMemErr.txt:** Logged errors with additional information such as date/time and file name/line number (for developers).

**LogMemStd.txt:** Logging of selected events.

**LogMemNet.txt:** Data latest send via port 9100.

**Parameters.log:** All printer parameters in human readable form.

**TaskStatus.txt:** Status of all printer tasks.

The files *LogMemErr.txt* and *LogMemStd.txt* are written in circle, i.e. old contents are overwritten. The entry logged last is marked with „---“.

## 6.12 Main Menu

Switch on the label printer and the display shows the main menu. The main menu shows information such as printer type, current date and time, version number of firmware and the used FPGA.

The selected display is shown for a short time, then the indication returns to the first information.

Press the key  to move to the next information display.

## 7 Options

### 7.1 Cutter



#### CAUTION!

Risk of injury, particularly during maintenance, the cutter blades are sharp!

- ⇒ Switch off the printer before attaching the cutter!
- ⇒ The cutter may only be used when it is mounted on the printer!
- ⇒ Do not try to cut any materials which exceed the maximum width or thickness specifications.
- ⇒ Do NOT touch the area of the moving blades!

Switch on the label printer and the display shows the main menu.

Press the key **F** to access the function menu.

Press the key  until the menu *Cutter* is displayed.

Press the key  to select the menu.



#### NOTICE!

The menu item cutter is only displayed if the printer recognizes the option via cutter photocell when switching on the printer.

In the upper line of display, the cutter mode can be selected.

In the line below, the cutter offset (approx. 20 mm) can be set.

Press the key  to change to the next operating mode.

### Operating modes

#### Off:

The print order is processed without cutting.

#### Without backfeed:

A cut is effected after each label.

We recommend using this operating mode if no data which is to print is in the upper part of the label.

#### With backfeed:

A cut is effected after each label.

#### Interval with final cut:

A cut is effected after a fixed number of labels which you have to enter at the print start and additionally at the end of the print order.

#### Interval without final cut:

A cut is effected after a fixed number of labels which you have to enter at the print start. At the end of the printer order no cut is effected except when the set interval comes to the end of the print order.

#### Final cut:

A cut is only effected at the end of the print order.

Select the desired cutter operating mode, then press the key  to select additional functions.

**Cutter control**

**Automatic:** After each printed label a cut is released.

**Extern:** A cut is released by an external I/O. External can only be selected if the label printer is equipped with option external I/O Nach jedem gedruckten Etikett wird ein Schnitt ausgelöst.

Press the key  to arrive the next menu item.

**Automatic return**

**On:** The label is pulled back immediately after the cut.

**Off:** The label is pulled back only before the next print.

**Single cut**

In case you are in the main menu or a print order has been stopped you can release a single cut by pressing the key .

The type of the single cut depends on the set cutter mode and offset.

## 7.2 Dispenser I/O



### NOTICE!

In order to operate the printer in dispenser mode a print order has to be started and the printer has to be in 'waiting' mode.

Switch on the label printer and the display shows the main menu.

Press the key  to access the function menu.

Press the key  until the menu *Dispenser I/O* is displayed.

Press the key  to select the menu.

In the upper line of display, the operating mode can be selected.

### Dispenser offset

In the line below, the dispenser I/O offset (approx. 20 mm) can be set.

Press the key  to change to the next operating mode.

### Operating modes

#### Off:

It is printed without the labels are dispensed.

#### I/O static:

The input signal evaluated, i.e. it is printed as long as the signal exists. The number of labels which was entered at the print start is printed.

The set dispenser offset is not taken into consideration.

#### I/O static continuous:

For description of this operating mode, see I/O static.

Continuous means that it is printed as long as new data is transferred via interface

The set dispenser offset is not taken into consideration.

#### I/O dynamic:

The external signal is evaluated dynamically, i.e. is the printer in 'waiting' mode a single label is printed at each signal changing. After the print the set dispenser offset is executed, i.e. a backfeed is effected.

#### I/O dynamic continuous:

For description of this operating mode, see I/O dynamic.

Continuous means that it is printed as long as new data is transferred via interface.

#### Photocell:

The printer is controlled via photocell. The printer prints automatically a label if the user takes away the label at the dispensing ledge. The print order is finished when the target number of labels is reached.

#### Photocell continuous:

For description of this operating mode, see Photocell.

Continuous means that it is printed as long as new data is transferred via interface.

**Additional parameters for Dispenser I/O**

After selection of desired Dispenser I/O operating mode, press the key  to select additional parameters.

**Dispenser photocell**

- First value = Indication of the current sensor level. This indication is for checking purposes and cannot be modified.
- Second value = Indication if a label (value = 1) or if no label (value = 0) was found. This indication is for checking purposes if the set switch level leads to a correct label recognition.
- Third value = Indication of switch level (Default: 1.2).
- Fourth value = Transmission power of label sensor [1..255] Depending on label material (color) the sensor level can be adapted in order to permit a safe label recognition (Default: 80).

**NOTICE!**

The modification of this value is only taken into consideration for the operating modes *Photocell* and *Photocell continuous*.

Press the key  to move to the next parameter.

**I/O Port 1-8 and I/O Port 9-16**

Definition of port functions:  
2 sign show the current setting for each port.

```
Vita V 106/12
I/O Port 1-8
I+I+I+I+N+N+N+N+
```

Port 1 2 3 4 5 6 7 8

because of space reasons, the port number cannot be indicated)

The first sign specifies the following:

- I** = Port operates as Input
- O** = Port operates as Output
- N** = Port has no function (not defined)

These settings cannot be modified.

The second sign specifies the following:

- +** = Active signal level is 'high' (1)
- = Active signal level is 'low' (0)
- x** = Port is deactivated
- &** = Function is executed at each change of the signal level
- s** = Status can be enquired/influenced by interface  
The printer-internal function is deactivated.

The modification of the signal level is only taken into consideration for the operating modes I/O static, I/O dynamic, I/O static continuous and I/O dynamic continuous.

Press the key  to move to the next parameter.

**Debounce**

Indication of debounce time of the dispenser input. The setting range of the debounce time is between 0 and 100 ms.

In case the start signal is not clear then you can debounce the input by means of this menu item.

Press the key  to move to the next parameter.

**Start signal delay**

Indication in time per second of the delay for the start signal.

Value range: 0.00 ... 9.99.

Press the key  to move to the next parameter.

**I/O protocol**

Indication of interface at which the modifications of input signals and output signals (I/O) are sent.

Press the key  to move to the next parameter.

**Save signal**

**On:** The start signal for the next label can already be released during printing the current label. The signal is registered from the printer. The printer starts printing the next label immediately after finishing the current one. Therefore time can be saved and performance be increased.

**Off:** The start signal for the next label can only be released if the current label is printed to the end and the printer is again in 'waiting' state (output 'ready' set). If the start signal was released already before, so this is ignored.

Press the key  to move to the next parameter.

**I/O Profile**

Selection of the available configurations *Std\_Label* (factory setting), *StdFileSelLabel* or *APL*.

**List of registered functions for *Std\_Label***

1	Print start and cut (Input)
2	Reprint last printed label (Input)
3	Counter reset (Input)
4	Option applicator only: Start application (Input)
5	Error reset (Input)
6	Cancel all print jobs (Input)
7	No function
8	No function
9	Error (Output)
10	Print order active (Output)
11	Dispenser photocell: Label exists at dispenser photocell (Output)
12	Printing (Output)
13	Ready (Output)
14	Option applicator only: Ready for application (Output)
15	Option scanner only Bar code not readable (Output)
16	Transfer ribbon prior warning (Output)

**List of registered functions for StdFileSelLabel**

1	Print start and cut (Input)
2*	Error reset (Input)
3*	Number of the file to load Bit 0 (Input)
4*	Number of the file to load Bit 1 (Input)
5*	Number of the file to load 2 (Input)
6*	Number of the file to load 3 (Input)
7*	Number of the file to load 4 (Input)
8*	Number of the file to load 5 (Input)
9	Error (Output)
10	Print order active (Output)
11	Dispenser photocell: Label exists at dispenser photocell (Output)
12	Printing (Output)
13	Ready (Output)
14	No function
15	Option scanner only: Bar code not readable (Output)
16	Transfer ribbon prior warning (Output)

\* The files must be saved onto the SD card in the user directory (see chapter 9.4, page 82.

The files must start with 1 or 2 digits (1\_Etikett.prn, 02\_Etikett.prn).

The files can be saved with a file extension.

In the printer status 'ready', 'waiting' or 'stop', a new file can be loaded. The printer order will be started after charging and an already existing printer order will be deleted.

The input signal 000000 does not charge a file and does not delete an already existing print order.

**List of registered functions for APL**

1	Print start and cut (Input)
2	Reprint last printed label (Input)
3	Counter reset (Input)
4	Option applicator only: Start application (Input)
5	Error reset (Input)
6	Cancel all print jobs (Input)
7	No function
8	No function
9	Error (Output)
10	Print order active (Output)
11	Dispenser photocell: Label exists at dispenser photocell (Output)
12	Printing (Output)
13	Ready (Output)
14	Option applicator only: Ready for application (Output)
15	Option applicator only: Pad is in printing position (Output)
16	Transfer ribbon prior warning (Output)



### 7.3 WLAN

Switch on the label printer and the display shows the main menu.

Press the key  to access the function menu.

Press the key  until the menu *WLAN* is displayed.

Press the key  to select the menu.

The menu item WLAN can only be selected if a USB-WLAN stick was recognized when switching on the printer.

For more information, please see the separate manual.

## 7.4 Scanner

Switch on the label printer and the display shows the main menu.

Press the key **F** to access the function menu.

Press the key  until the menu *Scanner* is displayed.

Press the key  to select the menu.

### Mode

- 0 Off
- 1 Mode 1 (data comparison)  
i.e. bar code data which was read by the scanner is compared with the printed data.
- 2 Mode 2 (check readability)  
i.e. it is only checked if the scanner can read the printed bar codes.
- 3 Mode 3 (check readability, graphic), i.e. it is only checked if the scanner can read the printed bar codes. This mode is to use if the bar code is available as graphic (e.g. printing with printer driver). In this case the printer cannot recognize that a bar code is placed onto the label.

### NoRd = Non readables

Indication of number of successive non readables, i.e. when the printer indicates an error message.

Value range: 0 ... 9

1 = the printer stops at the first label which cannot be read from the scanner and shows an error message.

0 = the printer do not stop at non-readable. A message appears at the display only.

### VEtik = Label feeding

In many cases it is impossible to position the scanner directly at the printhead, and therefore with this setting a feeding can be set

Value range: 1 ... 5

The illustration below clarifies the meaning of this parameter.

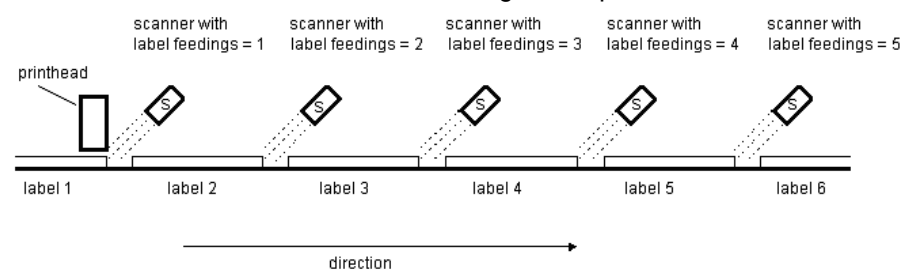

Press the key  to move to the next menu item.

### Scanner type

Selection of the connected scanner type.

For more information about the different scanner models, please contact our sales department.

Press the key  to move to the next menu item.

### Scanner setup

Positioning of scanner. First of all, the scanner must be connected, the appropriate scanner must be selected in the scanner type menu, the interface must be activated in the interface parameter menu and the interface parameters must be set correctly.

Press the key  to move to the next menu item.

### Scan offset

Indication of value at which the label is moved so the scanner can read data onto the label.

Press the key  to move to the next menu item.

### Scan length

If this parameter is set to 0 (AUTO), the switch on and off position of scanner is calculated by means of position and height of bar code onto the label.

If the parameter Scan Length is not 0, so this defines the length of scan sector. The start of scan sector is then set by the parameter Scan Offset. The following drawing shows the meaning of parameter.

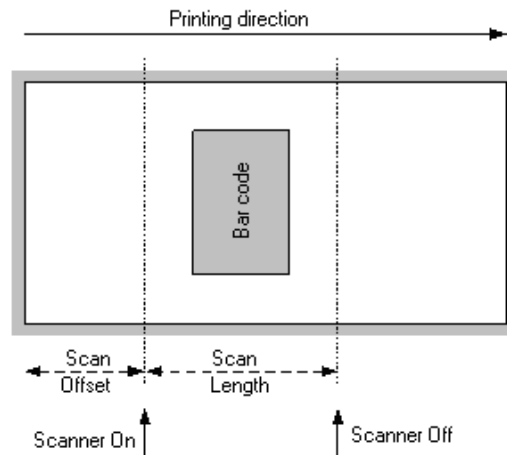

**Figure 12**

Press the key  to move to the next menu item.

### Scan mode

With this parameter can be adjusted, at which time the scanning of the bar code is to be effected - during printing or after printing.

Press the key  to move to the next menu item.

### Scan delay

In scan mode 'after print' the scanner is switched On after the label was printed. With this value the time can be specified between printing the label and switching On the scanner.

Press the key  to move to the next menu item.

### Scan timeout

In scan mode 'after print' can be specified with this value the time which is available for scanning the label.

Press the key  to move to the next menu item.

### Interface

To use a scanner, the COM2 interface is set to 1.

For more information, please see the separate manual.



## 8 SD Card / USB Memory Stick

### 8.1 General Information

On the back side of the label printer is the slot for the SD card and the USB port for inserting the USB memory stick.

The mass storage menu (memory menu) permits the access to SD cards or USB memory sticks attached to the printer. Among loading and saving labels simple operations of contents are possible such as delete files/directories, copy files/directories or formatting.



#### NOTICE!

In case of a malfunction of the original memory medium it is recommend to copy the most important data by means of a commercial Card Reader.

### 8.2 Display Structure

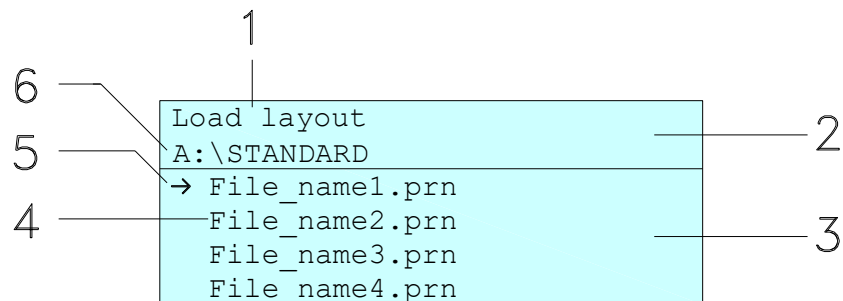

1 = Current function

2 = 2-lined header

3 = Scroll range

4 = File names / directory names

5 = Marking of the selected file (cursor)

6 = Current path (drive:\directory)

The two-line header (2) contains the current function name (1) and the current path (6).

The four-line scroll range indicates a list of files/directories. The first entry (marked with an arrow) is the active one. To this file/directory and/or these files/directories refer all actions.



#### NOTICE!

Three drives are available.



















A:\ indicates the SD card.

U:\ indicates the USB memory stick.  
(only one stick can be inserted)

R:\ indicates the RAM (ZPL Emulation).

### 8.3 Navigation

The memory menu is operated with the keys of the foil keyboard of the control unit or with different function keys of an attached USB keyboard.

		Return to the previous menu.
		Function <i>Load layout</i> : Change to the File Explorer. File Explorer: Change to the 'context menu'.
		Select a file/directory if a multiple selection is possible.
		Main menu: Access to the memory menu. File Explorer: Create a new file.
		Start the current function for the active file/directory.
		Change to the superordinate directory.
		Change to the currently marked directory.
		In the current directory scroll upwards.
		In the current directory scroll downwards.

## 8.4 Define User Directory



### NOTICE!

An user directory is to be defined:

- before using and/or navigating through the memory menu.
- if formatting of SD card is effected at PC and thus the STANDARD directory was not created automatically.

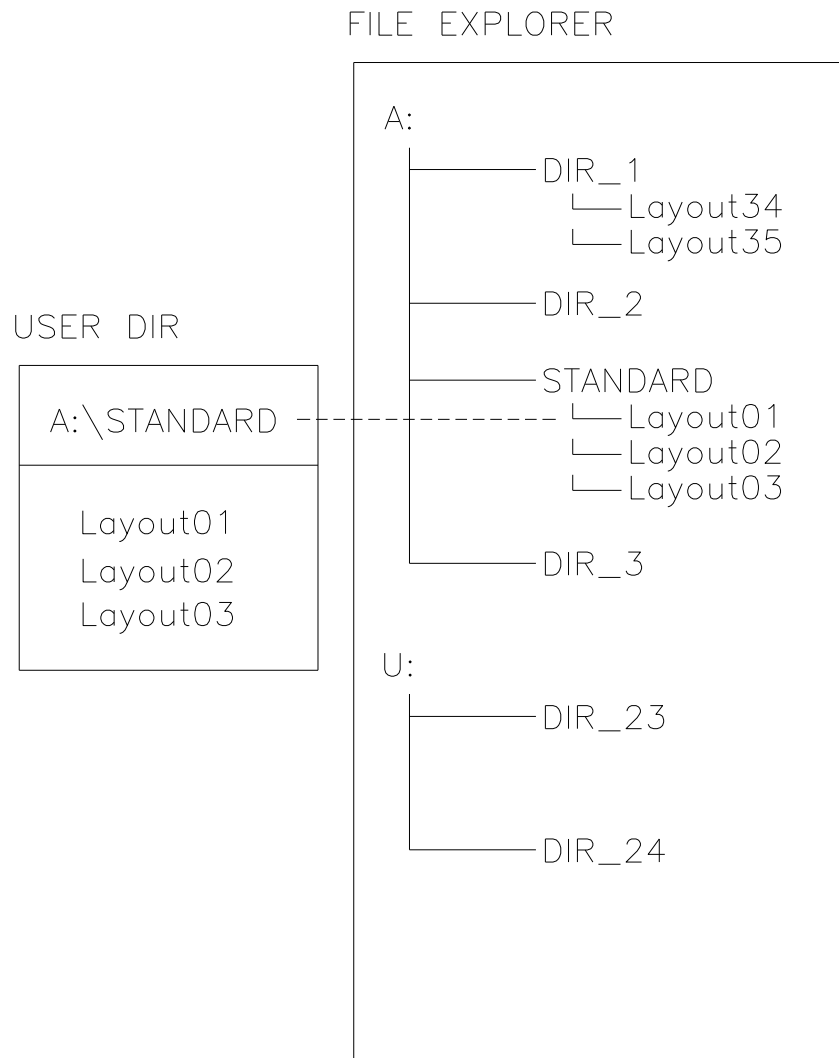

The user directory is the root directory in which the user saves usually the most frequently used files/layouts. The utilisation of the user directory permits the quick and direct access to the files saved in the defined user directory. The definition of an user directory saves thus a long search of the file to be printed.

Press the key  to access the memory menu.

Press the key  to call the File Explorer.

File Explorer A:\	Context Menu A:
[Drives] -><STANDARD> <DIR_1>	->Set as user dir Format Copy

Press the keys , , ,  to select the directory.

Press key  to display all available functions.

Select the function *Set as user dir* and press the key  to confirm the selection.

Press the key  until the printer is back in the main menu.





At the next start of the memory menu the selected directory is displayed as user directory.

## 8.5 Load Layout

Loads a layout within a defined user directory. The function allows quick access to the desired layout as only layout files are displayed and directories hidden.

Load layout A:\STANDARD
->File_name1.prn File_name2.prn File_name3.prn File_name4.prn

Press the key  to access the memory menu.

Press the keys , , ,  to select the layout to be printed.

Press the key  to confirm the selection.

The printer display shows automatically the window to insert the number of copies which are to print.

Select the number of copies which are to be printed.

Press the key  to start the print order.



### NOTICE!

The directory can NOT be changed. A change of directory MUST be made in the File Explorer with the function *Change directory*.



## 8.6 File Explorer

The File Explorer is the file manager of the printing system. The File Explorer provides the main functions for the user interface of memory menu.

In the user directory, press the key **F** to access the File Explorer.

Following functions are available:

- Change drive and/or directory
- Load file
- Save layout and/or configuration
- Delete file(s)
- Format SD card
- Copy file(s)

### Change drive/directory

Selection of drive and/or directory in which the files are saved.

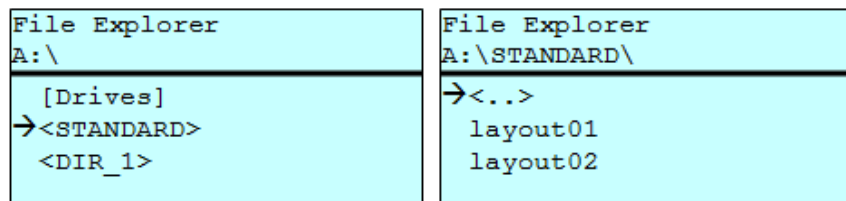

Press the key **F** to access the memory menu.

Press the key **F** to call the File Explorer.

Press the keys **↑**, **↓**, **←**, **→** to select the directory.

Press the key **Enter** to confirm the selection.

The selected directory is now displayed.



**Load file**

Loads a file. This can be a configuration saved before, a layout, etc.

```
Load file
A:\STANDARD\
-----
<..>
->layout01
   layout02
```

Press the key  to access the memory menu.

Press the key  to call the File Explorer.

Press the keys  and  to select the file.

Press the key  to load the selected file.

If the selected file is a layout, then the number of copies to print can be entered immediately.

**Save layout**

Saves the currently loaded layout under the selected name.

```
Save file
A:\STANDARD
-----
->Save layout
   Save config.
noname
```

Press the key  to access the memory menu.

Press the key  to call the File Explorer.

Press the key  to move to the menu *Save file*.

Select the function *Save layout* and press the key  to confirm the selection.

If an USB keyboard is attached a new file name for *noname* can be assigned.

**Save configuration**

Saves the complete, current printer configuration under the selected name.

```
Save file
A:\STANDARD
-----
Save layout
→ Save config.
-----
config.cfg
```

Press the key  to access the memory menu.

Press the key  to call the File Explorer.

Press the key  to move to the menu *Save file*.

Select the function *Save configuration* and press the key  to confirm the selection.

If an USB keyboard is attached a new file name for *config.cfg* can be assigned.



**Delete file(s)**

Deletes one or more files and/or directories irrevocably. With the deletion of a directory both the contained files and the subdirectories are deleted.

File Explorer A:\STANDARD\ ----- layout01 * → layout02 * layout03 layout04	Context menu 2 objects marked ----- → Delete Copying
--	--

Press the key  to access the memory menu.

Press the key  to call the File Explorer.

Press the keys  and  to select the file.

Press the key  to mark the files which are to be deleted. The marked entries are listed with \*. Repeat this procedure until all desired files and/or directories are marked for deletion.

Press the key  to call the context menu.

Select the function *Delete* and press the key  to confirm the selection.

**NOTICE!**

The deleting procedure is irreversible!

**Format memory card**

Formats irrevocably the memory card.

**NOTICE!**

USB sticks cannot be formatted at the printer!

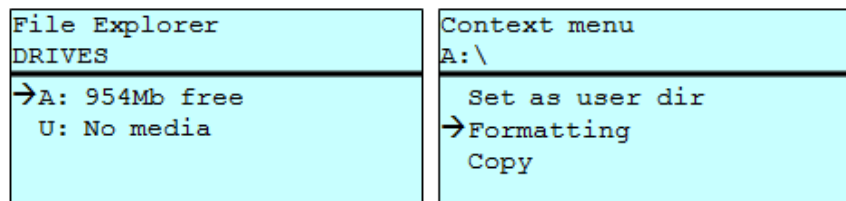

Press the key  to access the memory menu.

Press the key  to call the File Explorer.

Select the drive which is to format with the navigation keys.

Press the key  to call the context menu.

Select the function *Format* and press the key  to confirm the selection.



**Copy memory card**

Creates a duplicate of the original file and/or the original directory to make changes independently of the original.

File Explorer A:\STANDARD\ layout01 * → layout02 * layout03 layout04	Context menu 2 objects marked Delete → Copying
---	---

Press the key  to access the memory menu.

Press the key  to call the File Explorer.

Press the keys  and  to select the file.

Press the key  to mark the files which are to be copied. The marked entries are listed with \*. Repeat this procedure until all desired files and/or directories are marked for copying.

Press the key  to call the context menu.

Select the function *Copy* and press the key with the key  to confirm the selection.

Select Destination DRIVES → A: 954Mb free
---

Select the target storage with the navigation keys and press the key  to confirm the selection.

## 8.7 Firmware Update

Starting from firmware version 1.58, updates can be performed via the memory menu. Both the USB stick as well as the SD card can be used for this.

### Procedure

On the SD card/USB memory stick a directory is created in which the necessary update files are stored (firmware.prn, data.prn). By means of the function *Load file* the file *firmware.prn* is selected/loaded. In the first step the printer executes the firmware update. After the necessary restart automatically the file *data.prn* is loaded. In this way the remaining components were updated. is After a renewed restart the update procedure is finished.

## 8.8 Filter

For certain functions a filter mask or a file name of a file which is to be saved can be entered. This input is indicated in the path line. The filter mask can be used to search for specific files. For example, with the input of 'L' only the files are listed whose character string starts with 'L' (regardless of upper and lower cases).

### Without filter

```
Load layout
A:\STANDARD
→First_file.prn
  Layout_new.prn
  Sample.prn
  12807765.prn
```

### With filter

```
Load layout
L
→Layout_new.prn
```

## 9 Maintenance and Cleaning



### DANGER!

Risk of death by electric shock!

⇒ Before opening the housing cover, disconnect the device from the mains supply and wait for a moment until the power supply unit has discharged.



### NOTICE!

When cleaning the label printer, personal protective equipment such as safety goggles and gloves are recommended.

### Maintenance plan

Maintenance task	Frequency
General cleaning (see section 9.1, page 80).	As necessary.
Clean the transfer ribbon drawing roller (see section 9.2, page 81).	Each time the transfer ribbon is changed or when the printout is adversely affected.
Clean the pressure roller (see section 9.3, page 81).	Each time the label roll is changed or when the printout and label transport are adversely affected.
Clean the printhead (see section 9.4, page 82).	<b>Direct thermal printing:</b> Each time the label roll is changed. <b>Thermal transfer printing:</b> Each time the transfer ribbon is changed or when the printout is adversely affected.
Clean the label photocell (see section 9.5, page 83).	When replacing the label roll.
Replace the printhead (see section 9.6, page 84).	In case of errors in printout.



### NOTICE!

The handling instructions for the use of Isopropanol (IPA) must be observed. In the case of skin or eye contact, immediately wash off the fluid thoroughly with running water. If the irritation persists, consult a doctor. Ensure good ventilation.

**WARNING!**

Risk of fire by easily inflammable label soluble!

- ⇒ When using label soluble, dust must be completely removed from the label printer and cleaned.

## 9.1 General Cleaning

**CAUTION!**

Abrasive cleaning agents can damage the label printer!

- ⇒ Do not use abrasives or solvents to clean the outer surface of the label printer.
- ⇒ Remove dust and paper fuzz in the printing area with a soft brush or vacuum cleaner.
- ⇒ Clean the outer surfaces with an all-purpose cleaner.

## 9.2 Clean the Transfer Ribbon Drawing Roller

A soiled drawing roller can lead to reduced print quality and can affect transport of material.

1. Open the printer cover.
2. Turn the lever (A, Figure 13) counter clockwise to lift up the printhead (B, Figure 13).
3. Remove labels and transfer ribbon from the label printer.
4. Remove deposits with the roller cleaner and a soft cloth.
5. Turn the roller (D, Figure 13) manually step by step to clean the complete roller (only possible when the printer is switched off, as otherwise the step motor is full of power and the roller is kept in its position).
6. Reload labels and transfer ribbon.
7. To move the printhead (B, Figure 13) down, turn the pressure lever (A, Figure 13) in clockwise direction until it locks.
8. Close the printer cover.



### 9.3 Clean the Pressure Roller

A soiled pressure roller can lead to reduced print quality and can affect transport of material.



#### CAUTION!

Pressure roller can be damaged!

⇒ Do not use sharp or hard objects to clean the pressure roller.

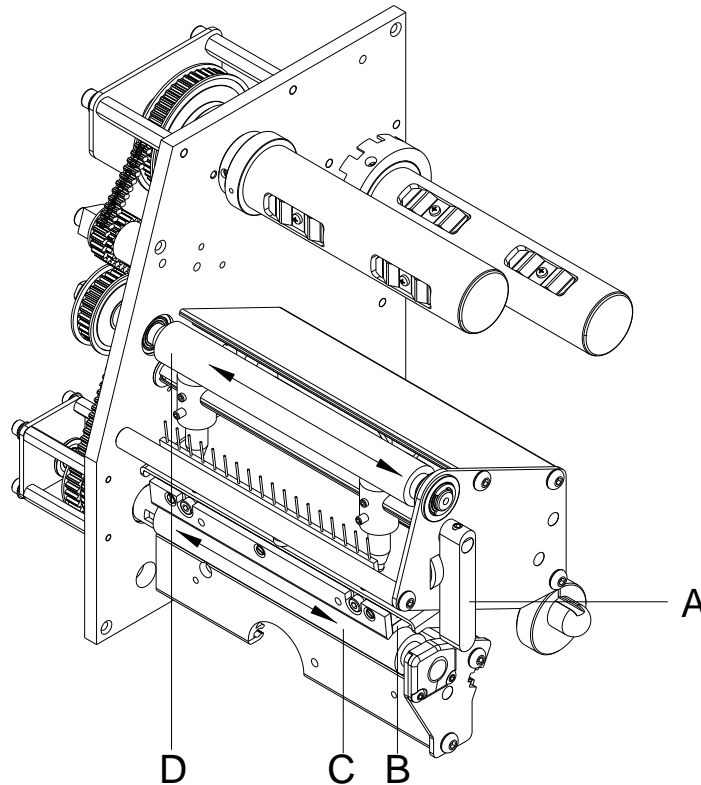

**Figure 13**

1. Open the printer cover.
2. Turn the lever (A) counter clockwise to lift up the printhead (B).
3. Remove labels and transfer ribbon from the label printer.
4. Remove deposits with the roller cleaner and a soft cloth.
5. Turn the roller (C) manually step by step to clean the complete roller (only possible when the printer is switched off, as otherwise the step motor is full of power and the roller is kept in its position).
6. Insert again the transfer ribbon material.
7. To move the printhead down, turn the pressure lever (A) in clockwise direction until it locks.
8. Close the printer cover.

## 9.4 Clean the Printhead

Printing can cause accumulation of dirt at printhead e.g. by colour particles of transfer ribbon, and therefore it is necessary to clean the printhead in regular periods depending on operating hours, environmental effects such as dust etc.



### CAUTION!

Printhead can be damaged!

- ⇒ Do not use sharp or hard objects to clean the printhead.
- ⇒ Do not touch the protective glass layer of the printhead.

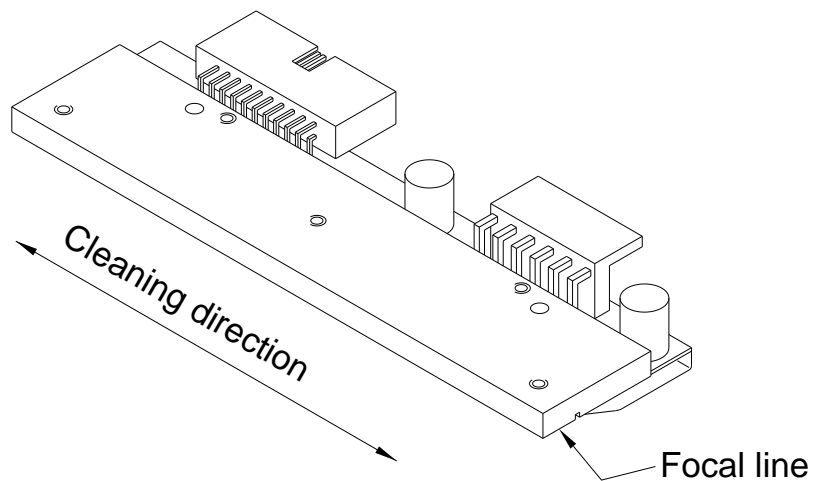

**Figure 14**

1. Open the printer cover.
2. Turn the red lever (A, in Figure 13) counter clockwise to lift up the printhead.
3. Remove labels and transfer ribbon from the label printer.
4. Clean the printhead surface with a special cleaning pen or a cotton swab dipped in pure alcohol.
5. Before using the label printer, let the printhead dry for about two to three minutes.
6. Insert again the transfer ribbon material.
7. To move the printhead down, turn the pressure lever (A, Figure 13) in clockwise direction until it locks.
8. Close the printer cover.

## 9.5 Clean the Label Photocell



### CAUTION!

Label photocell can be damaged!

⇒ Do not use sharp or hard objects or solvents to clean the label photocell.

The label photocell can be soiled with paper dust. This may affect the label scanning.

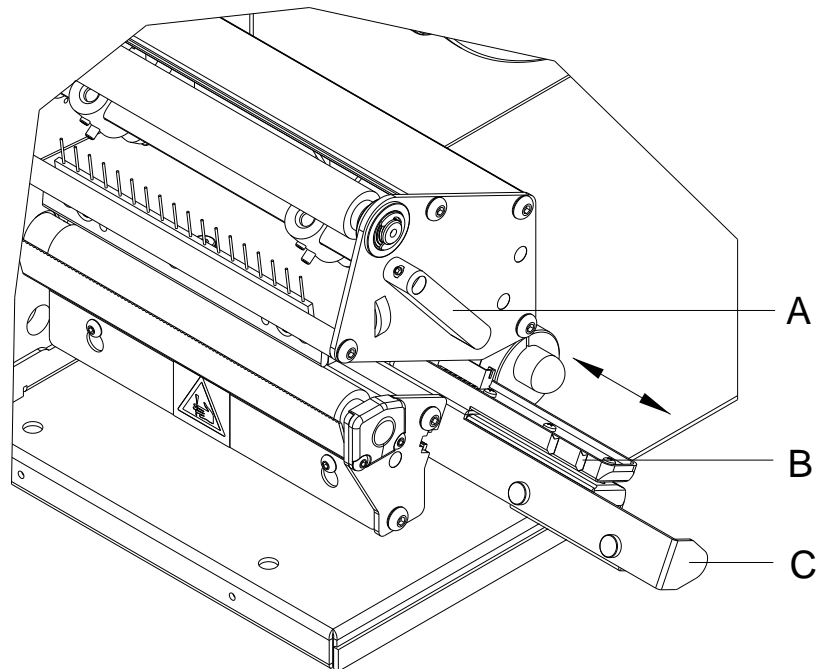

**Figure 15**

1. Open the printer cover.
2. Turn the lever (A) counter clockwise to lift up the printhead.
3. Remove labels and transfer ribbon from the label printer.
4. Pull the label photocell slowly outwards via the tab (C). Ensure that the label photocell cable is not tensioned by this.
5. Clean the label photocell and sensor units (B) with a brush or cotton swab soaked in pure alcohol.
6. Push the label photocell back via tab (C) and set it.
7. Reload the labels and transfer ribbon (see chapter 5 Load Media, page 29).
8. To move the printhead down, turn the pressure lever (A) in clockwise direction until it locks.
9. Close the printer cover.

## 9.6 Replace the Printhead (General)



### CAUTION!

The printhead can be damaged by static electricity discharges and impacts!

- ⇒ Set up the printer on a grounded, conductive surface.
- ⇒ Ground your body, e.g. by wearing a grounded wristband.
- ⇒ Do not touch the contacts on the plug connections (B, C).
- ⇒ Do not touch the printing line (E) with hard objects or your hands.

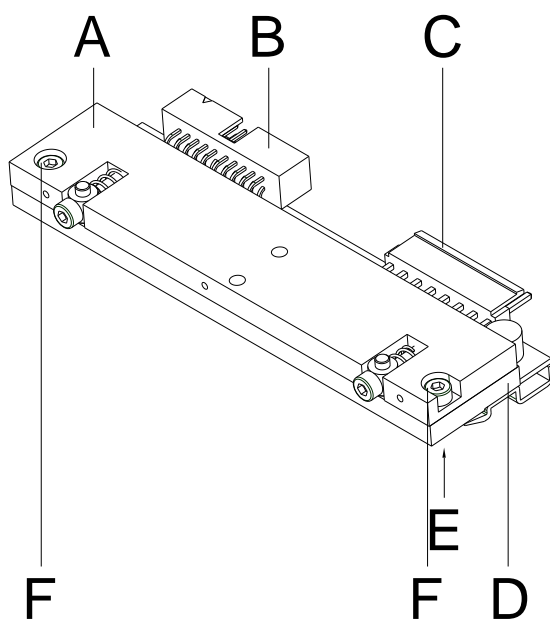

- A Head plate
- B Plug connection signal
- C Plug connection voltage
- D Printhead
- E Focal line
- F Screw

Figure 16



### NOTICE!

The printhead (D) is preinstalled on a head plate (A) and aligned at the factory.



### CAUTION!

Danger of abrasion when removing/installing the printhead!

- ⇒ Pay attention to the toothing when the tear-off edge is installed.

## 9.7 Replace the Printhead

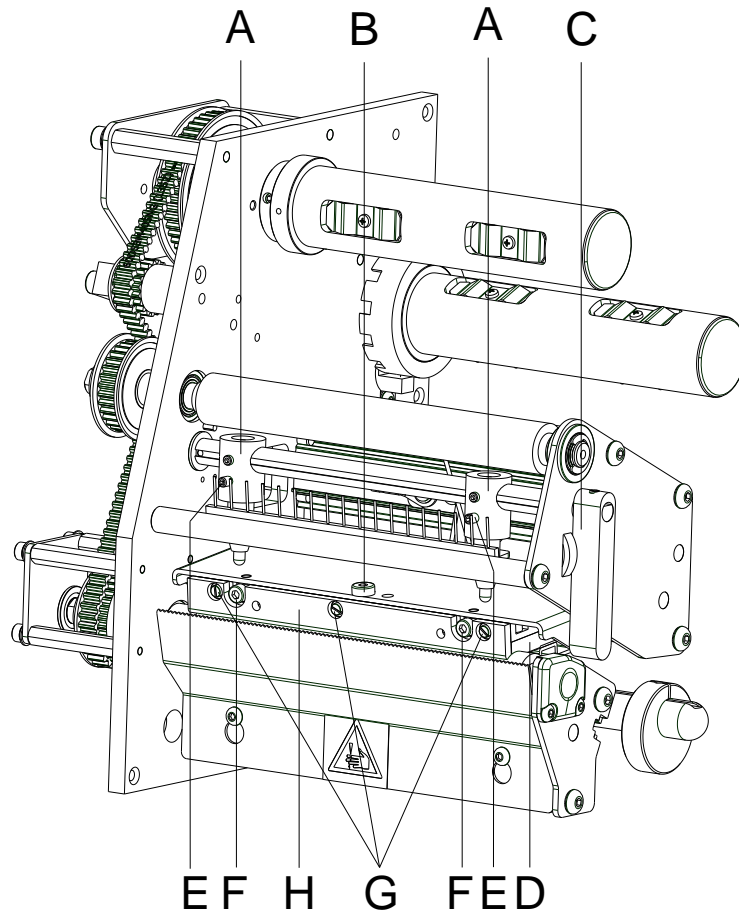

Figure 17

### Remove the printhead

1. Open the printer cover.
2. Remove labels and transfer ribbon from the label printer.
3. When the printhead is closed, loosen the fixing screw (B).
4. Turn the pressure lever (C) counter clockwise to lift up the printhead.
5. If the printhead (D) is not disengaged on the pressure roller, continue loosen the fixing screw (B).
6. Remove the printhead carefully to the front until you can reach the plug connections.
7. Remove the plug connections and then remove the printhead (D).
8. Loosen the fixing screws (G) and remove the guiding (H).

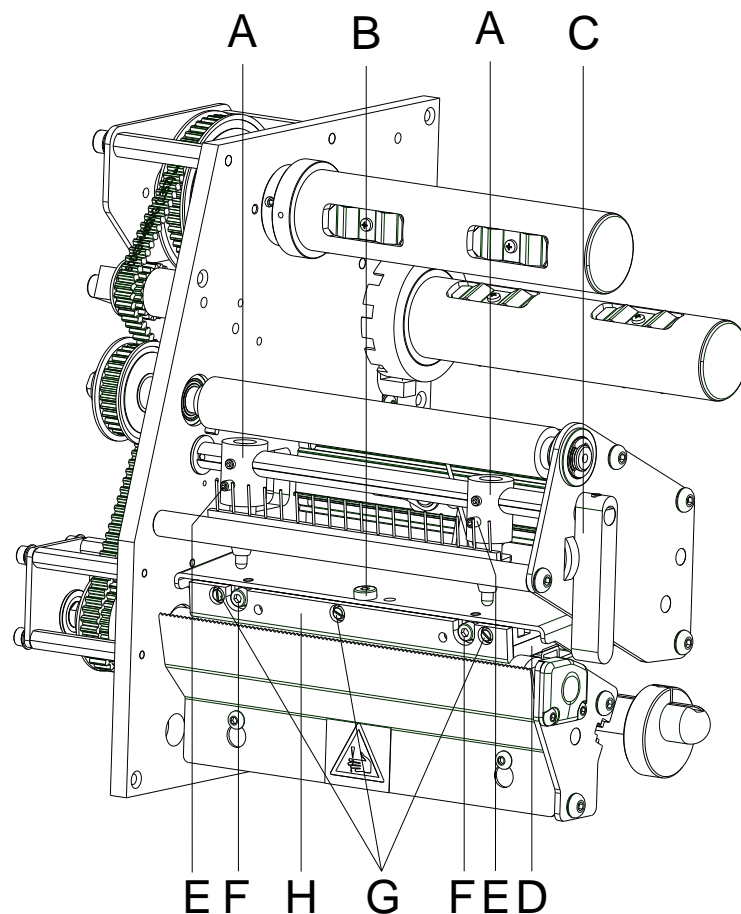
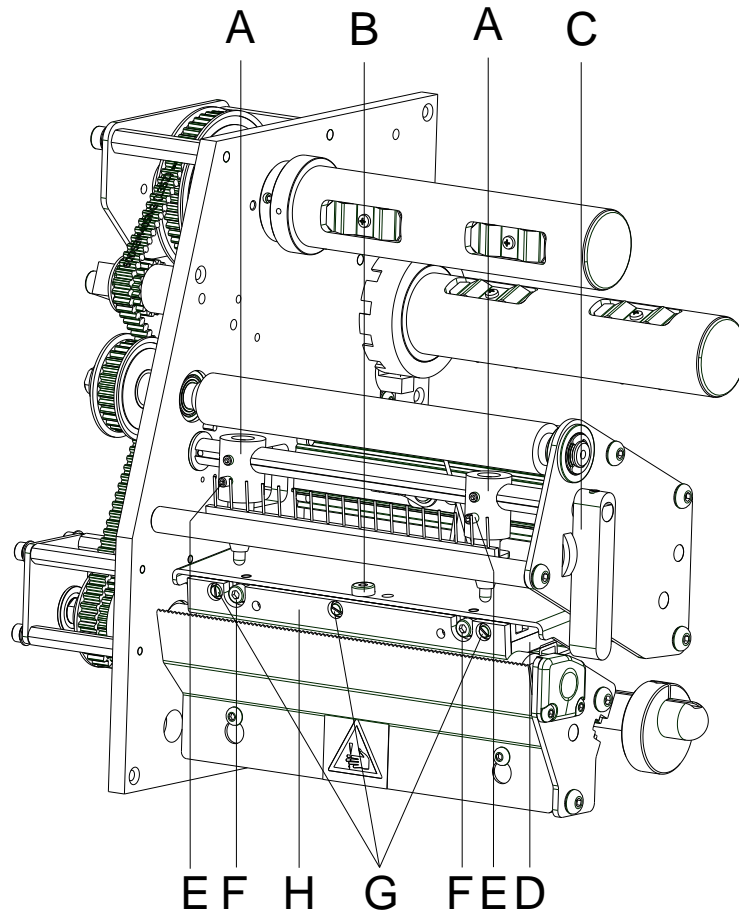

Figure 18

**Install the printhead**

1. Mount the guiding (H) and fixing screws (G) at the printhead.
2. Attach the plug connections.
3. Position the printhead in the printhead mounting bracket in such a way that the pins are secured in the corresponding holes in the head plate.
4. Lightly keep the printhead mounting bracket on the pressure roller with one finger and check for correct positioning of the printhead.
5. Screw in the fixing screw (B) and tighten it.
6. Reload labels and transfer ribbon (see chapter 5 Load Media, page 29).
7. To move the printhead down, turn the pressure lever (C) in clockwise direction until it locks.
8. Close the printer cover.
9. Check the resistance value on the type plate of printhead and if necessary change the value in the menu *Service functions/Heater resistance*.

## 9.8 Adjust the Printhead



**Figure 19**

### Parallelism

An important characteristic for a high quality print is the parallelism of the focal line of the thermal printhead to the pressure roll. Because of the fact that the position of focal line of the printhead depends on fluctuations caused by production, it is necessary to adjust the parallelism.

1. Loosen the fixing screw (B) approx. ¼ rotations.
2. Adjust the parallelism with the adjusting screws (F).  
Clockwise = printhead moves forwards  
Counter clockwise = printhead moves backwards
3. Adjust the parallelism as long as the printing result comes up to your full expectation.
4. Tighten again the fixing screw (B).
5. Start a print order with approx. 10 labels and control the correct passage of transfer ribbon.

## Pressure

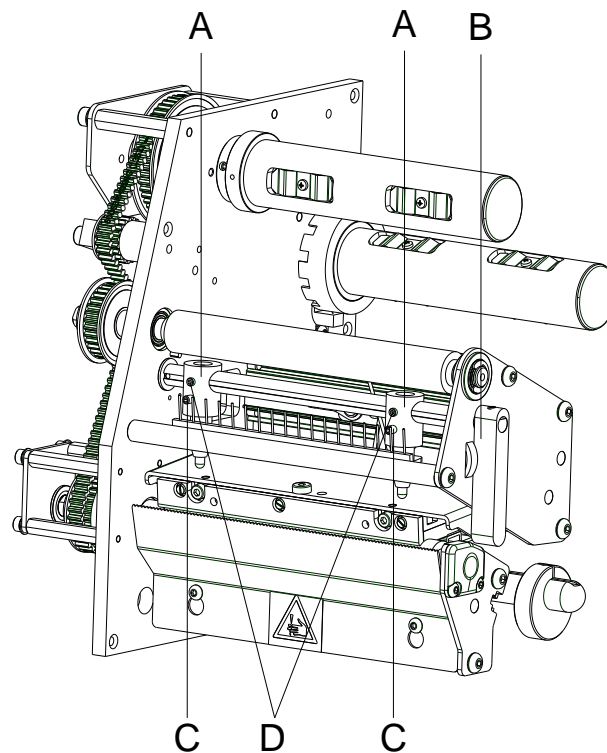

Figure 20

Increasing the head contact pressure leads to an improvement of the print image density on the corresponding side and to a shifting of the ribbon feed path in the corresponding direction.

**CAUTION!**

Damage of printhead by unequal use!

⇒ Only change the factory settings in exceptional cases.

The selection of the smallest value can optimise the life cycle of printhead.

1. Turn the lever (B) clockwise to lock the printhead.
2. The printhead is pushed on via two plungers (A). The location of the right plunger must be set to the width of the label medium used so as to:
  - achieve even print quality across the entire label width,
  - prevent wrinkles in the feed path of the transfer ribbon,
  - prevent premature wearing of the pressure roller and printhead.
3. Loosen the screw (D) by approx.  $\frac{1}{4}$  rotations.
4. Position the right plunger (A) above the outer label edge.
5. Tighten again the screw (D).
6. Turn the pressure screws (C) to change the pressure of printhead. Turning the pressure screws:
  - in clockwise direction increases the pressure
  - anticlockwise reduces the pressure.



## 10 Error Correction

Error message	Cause	Remedy
1 Line too high	Line rises up completely or partly over the upper edge of label.	Move line down (increase Y value). Check rotation and font.
2 Line too low	Line rises up completely or partly over the bottom edge of label.	Move line up (reduce Y value). Check rotation and font.
3 Character set	One res. several characters of the text is res. are not available in the selected font.	Change text. Change font.
4 Unknown BC type	Selected code is not available.	Check code type.
5 Illegal rotation	Selected rotation is not available.	Check rotation.
6 CV font	Selected font is not available.	Check font.
7 Vector font	Selected font is not available.	Check font.
8 Measuring label	While measuring no label was found. Set label length is too large.	Check label length and if labels are inserted correctly. Restart measuring anew.
9 No label found	No label available. Soiled label photocell. Labels not inserted correctly.	Insert new label roll. Check if labels are inserted correctly. Clean the label photocell.
10 No ribbon	During the print order the ribbon roll becomes empty. Defect at the transfer ribbon photocell.	Change transfer ribbon. Check transfer ribbon photocell (service functions).
11 COM FRAMING	Stop bit error.	Check stop bits. Check baud rate. Check cable (printer and PC).
12 COM PARITY	Parity error.	Check parity. Check baud rate. Check cable (printer and PC).
13 COM OVERRUN	Loss of data at serial interface (RS-232).	Check baud rate. Check cable (printer and PC).
14 Field number	Received line number is invalid.	Check sent data. Check connection PC - printer.
15 Length mask	Invalid length of received mask statement.	Check sent data. Check connection PC - printer.

<b>Error message</b>	<b>Cause</b>	<b>Remedy</b>
16 Unknown mask	Transferred mask statement is invalid.	Check sent data. Check connection PC - printer.
17 Missing ETB	No end of data found.	Check sent data. Check connection PC - printer.
18 Invalid character	One res. several characters of the bar code is res. are not valid.	Change bar code data. Change font.
19 Invalid statement	Unknown transferred data record.	Check sent data. Check connection PC - printer.
20 Invalid check digit	For check digit control the entered res. received check digit is wrong.	Calculate check digit anew. Check code data.
21 Invalid SC code	Selected SC factor is invalid for EAN res. UPC.	Check SC factor.
22 Invalid number of digits	Entered digits for EAN res. UPC are invalid < 12; > 13.	Check number of digits.
23 Type check digit	Selected check digit calculation is not available in the bar code.	Check calculation of check digit. Check bar code type.
24 Invalid extension	Selected zoom factor is not available.	Check zoom factor.
25 Offset sign	Entered sign is not available.	Check offset value.
26 Offset value	Entered offset value is invalid.	Check offset value.
27 Printhead temperature	Printhead temperature is too high. Defective printhead sensing device.	Reduce contrast. Change printhead.
28 Cutter error	With cut an error occurred. Paper jam.	Check label run. Check cutter run.
29 Invalid parameter	Entered data do not correspond to the characters allowed from the application identifier.	Check code data.
30 Application Identifier	Selected application identifier is not available in GS1-128.	Check code data.
31 HIBC definition	Missing HIBC system sign. Missing primary code.	Check definition of HIBC code.
32 System clock	Real Time Clock function is selected but the battery is empty. Defective RTC.	Change battery. Change RTC component.

<b>Error message</b>	<b>Cause</b>	<b>Remedy</b>
33 No CF interface	Interrupted connection CPU - CF card. Defective CF card interface.	Check connection CPU - CF card interface. Check CF card interface.
34 No print memory	Not enough print memory available.	Check CF assembly on CPU.
35 Printhead open	At start of a print order the printhead is open.	Close the printhead and start print order anew.
36 BCD invalid format	BCD error Invalid format for the calculation of Euro variable.	Check entered format.
37 BCD overflow	BCD error Invalid format for the calculation of Euro variable.	Check entered format.
38 BCD division	BCD error Invalid format for the calculation of Euro variable.	Check entered format.
39 FLASH ERROR	Flash component error.	Run a software update. Change CPU.
40 Length command	Invalid length of the received command statement.	Check data sent. Check connection PC - printer.
41 No drive	CF card not found / not correctly inserted.	Insert CF card correctly.
42 Drive error	Impossible to read CF card (faulty).	Check CF card, if necessary change it.
43 Unformatted	CF Card not formatted.	Format CF card.
44 Delete directory	Attempt to delete the actual directory.	Change directory.
45 Invalid path	Too long indication of path.	Indicate a shorter path.
46 Drive write-protected	Memory card is write-protected.	Deactivate write protection.
47 Directory not file	Attempt to indicate a directory as file name.	Correct your entry.
48 File already open	Attempt to change a file during an access is active.	Select another file.
49 No file/directory	File does not exist on CF card.	Check file name.
50 Invalid file name	File name contains invalid characters.	Correct entry of name, remove special characters.
51 Internal file error	Internal file system error.	Please contact your distributor.

<b>Error message</b>	<b>Cause</b>	<b>Remedy</b>
52 Root full	The max. number (64) of main directory entries is reached.	Delete at least one main directory entry and create subdirectories.
53 Drive full	Maximum CF capacity is reached.	Use new CF Card, delete no longer required files.
54 File/directory exists	The selected file/directory already exists.	Check name, select a different name.
55 File too large	During copying procedure not enough memory space onto target drive available.	Use a larger target card.
56 No update file	Errors in update file of firmware.	Start update file anew.
57 Invalid graphic file	The selected file does not contain graphic data.	Check file name.
58 Directory not empty	Attempt to delete a not empty directory.	Delete all files and sub-directories in the desired directory.
59 No CF interface	No CF card drive found.	Check connection of CF card drive. Contact your distributor
60 No media	No CF card is inserted.	Insert CF card in the slot.
61 Webserver error	Error at start of web server.	Please contact your distributor.
62 Wrong PH FPGA	The direct print module is equipped with the wrong FPGA.	Please contact your distributor.
63 End position	The label length is too long. The number of labels per cycle is too much.	Check label length res. the number of labels per cycle.
64 Zero point	Defective photocell.	Change photocell.
65 Compressed air	Pressure air is not connected.	Check pressure air.
66 External release	External print release signal is missing.	Check input signal.
67 Column too wide	Wrong definition of column width res. number of columns.	Reduce the column width res. correct the number of columns.
68 Scanner	The connected bar code scanner signals a device error.	Check the connection scanner/printer. Check scanner (dirty).
69 Scanner NoRead	Bad print quality. Printhead completely soiled or defective. Print speed too high.	Increase contrast. Clean printhead or exchange (if necessary). Reduce print speed.

<b>Error message</b>	<b>Cause</b>	<b>Remedy</b>
70 Scanner data	Scanned data does not correspond to the data which is to print.	Exchange printhead.
71 Invalid page	As page number either 0 or a number > 9 is selected.	Select a number between 1 and 9.
72 Page selection	A page which is not available is selected.	Check the defined pages.
73 Undefined page	The page is not defined.	Check the print definition.
74 Format user guiding	Wrong format for customized entry.	Check the format string.
75 Format date/time	Wrong format for date/time.	Check the format string.
76 Hotstart CF	No CF card found.	If option hotstart was activated, a CF card must be inserted. Switch off the printer before inserting the memory card.
77 Flip/Rotate	Selection of print of several columns and also mirror/rotate.	It is only possible to select one of both functions.
78 System file	Loading of temporary hotstart files.	Not possible.
79 Shift variable	Faulty definition of shift times (overlapping times).	Check definition of shift times.
80 GS1 Databar	General GS1 Databar error.	Check definition and parameter of GS1 Databar code.
81 IGP error	Protocol error IGP.	Check sent data.
82 Time generation	Printing creation was still active at print start.	Reduce print speed. Use printers' output signal for synchronization. Use bitmap fonts to reduce generating time.
83 Transport protection	Both DPM position sensors (start/end) are active.	Displace zero point sensor Check sensors in service functions menu
84 No font data	Font and web data is missing.	Run a software update.
85 No layout ID	Layout ID definition is missing.	Define layout ID onto the label.
86 Layout ID	Scanned data does not correspond to defined ID.	Wrong label loaded from CF card.
87 RFID no label	RFID unit cannot recognize a label.	Displace RFID unit or use an offset.
88 RFID verify	Error while checking programmed data.	Faulty RFID label. Check RFID definitions

Error message	Cause	Remedy
89 RFID timeout	Error at programming the RFID label.	Label positioning. Faulty label.
90 RFID data	Faulty or incomplete definition of RFID data.	Check RFID data definitions.
91 RFID tag type	Definition of label data does not correspond with the used label.	Check storage partitioning of used label type
92 RFID lock	Error at programming the RFID label (locked fields).	Check RFID data definitions. Label was already programmed.
93 RFID programming	Error at programming the RFID label.	Check RFID definitions.
94 Scanner timeout	The scanner could not read the bar code within the set timeout time.	
	Defective printhead. Wrinkles in transfer ribbon. Scanner wrong positioned. Timeout time too short.	Check printhead. Check transfer ribbon. Position scanner correctly, corresponding to the set feeding. Select longer timeout time.
95 Scanner layout difference	Scanner data does not correspond to bar code data.	Check adjustment of scanner. Check scanner settings / connection.
96 COM break	Serial interface error.	Check settings for serial data transmission as well as cable (printer-PC).
97 COM general	Serial interface error.	Check settings for serial data transmission as well as cable (printer-PC).
98 No software printhead FPGA	No printhead-FPGA data available.	Please contact your responsible distributor.
99 Load software printhead FPGA	Error when programming printhead-FPGA.	Please contact your responsible distributor.
100 Upper position	Option applicator: Sensor signal up is missing.	Check input signals / compressed-air supply.
101 Lower position	Option applicator: Sensor signal down is missing.	Check input signals / compressed-air supply.
102 Vacuum plate empty	Option applicator: Sensor does not recognize a label at vacuum plate.	Check input signals / compressed-air supply.

<b>Error message</b>	<b>Cause</b>	<b>Remedy</b>
103 Start signal	Print order is active but device not ready to process it.	Check start signal.
104 No print data	Print data outside the defined label. Selection of wrong module type (design software).	Check selected module type. Check selection of left/right version.
105 Printhead	No original printhead is used.	Check the used printhead. Contact your distributor.
106 Invalid Tag type	Wrong Tag type. Tag data do not match the Tag type in the printer.	Adapt data or use the correct Tag type.
107 RFID inactive	RFID module is not activated. No RFID data can be processed.	Activate RFID module or remove RFID data from label data.
108 GS1-128 invalid	Transferred GS1-128 bar code is invalid.	Verify bar code data (see GS1-128 bar code specification).
109 EPC parameter	Error at EPC calculation.	Verify data (see EPC specification).
110 Housing open	When starting the print order the housing cover is not closed.	Close the housing cover and start the print order anew.
111 EAN.UCC code	Transferred EAN.UCC code is invalid.	Verify bar code data (see corresponding specification).
112 Print carriage	Printing carriage does not move.	Check gear belt (possibly broken).
113 Applicator error	Option applicator: Error while using applicator.	Check applicator.
114 Left position	Option applicator: Left final position switch is not in correct position.	Check LEFT final position switch for correct function and position. Check function of pneumatics for cross traverse.
115 Right position	Option applicator: Right final position switch is not in correct position.	Check RIGHT final position switch for correct function and position. Check function of pneumatics for cross traverse.
116 Print position	Option applicator: The applicator is not in the print position when trying to print a label.	Check TOP and RIGHT final position switch for correct function and position. Check pneumatics for function
117 XML parameter	The parameters in the XML file are not correct.	Please contact your responsible distributor.

<b>Error message</b>	<b>Cause</b>	<b>Remedy</b>
118 Invalid variable	Transferred variable is invalid with customized entry.	Select correct variable without customized entry and transfer it.
119 No ribbon	During the print order the ribbon roll becomes empty. Defect at the transfer ribbon photocell.	Change transfer ribbon. Check transfer ribbon photocell (service functions).
120 Wrong directory	Invalid target directory when copying.	Target directory must not be within the source directory. Check target directory.
121 No label PH2	No label found at the rear printhead (DuoPrint). Soiled label photocell. Labels not inserted correctly.	Insert new label roll. Clean the label photocell. Check if labels are inserted correctly.
122 IP occupied	The IP address was already assigned.	Assign a new IP address.
123 Print asynchronous	The label photocell do not work in the order as it is expected according to print data.  The settings of the photocell are not correct.  Settings of label size and gap size are not correct.  No label found at the rear printhead.  Soiled label photocell.  Labels not inserted correctly.	Check label size and gap size.  Check label photocell settings.  Check correct loading of label material.  Insert new label roll.  Clean the label photocell.  Check if labels are inserted correctly.
124 Speed too low	The print speed is too slow.	Increase the speed of customers' machine.
125 DMA buffer	Communication problem HMI.	Restart the printer.
126 UID conflict	Configuration RFID programming faulty.	Run RFID initialising.
127 Module not found	RFID module not available.	Check the RFID module connection.  Please contact your responsible distributor.
128 No release signal	No print release by higher-level control (customer machine).	Activate release signal at the higher-level control.



<b>Error message</b>	<b>Cause</b>	<b>Remedy</b>
129 Wrong firmware	Firmware does not match the used printer type.	Use firmware that fits to the printer type. Please contact your responsible distributor.
130 Language missing	Language file for the set printer language is not available.	Please contact your responsible distributor.
131 Wrong material	Label material does not fit to printing data.	User label material with suitable label and/or gap length.
132 Invalid mark-up tag	Invalid mark-up formatting characters in text.	Correct the formatting characters in the text.
133 Script not found	LUA script file not found.	Check the file name.
134 Script failure	LUA script is incorrect.	Check the script.
135 Script user error	Error in LUA script user input.	Correct the input value.
136 No reprint available	No label data for reprinting available.	Send new label data to the printer.
137 Printhead short circuit	Electrical short at the printhead.	Check the used printhead. Please contact your distributor.
138 Too less ribbon	Transfer ribbon ends.	Change transfer ribbon.
139 Rewinder error	Label band is torn	Load a new label roll. Stick together the label band.
140 Rewinder motor blocked	External rewinder motor is blocked.	Switch off the printing system and check mechanical resistance. Change the full label roll.
141 Hardware error	A hardware component could not be found.	Please contact your responsible distributor.
142 No print mechanics	No print mechanics connected.	Check connection (print mechanics – control unit)



## 11 Additional Information

### 11.1 Column Printing

With this printer several columns can be printed, i.e. the information of one column can be printed several times (depending on its width) on a label. Caused by this the use of the complete print width is possible and the generating time is enormously reduced.

For example four columns with a width of 25 mm or two columns with a width of 50 mm can be printed onto a label with a width of 100 mm. Please note that the first label is always the one with the largest x coordinate, i.e. it has the largest distance to the printhead.

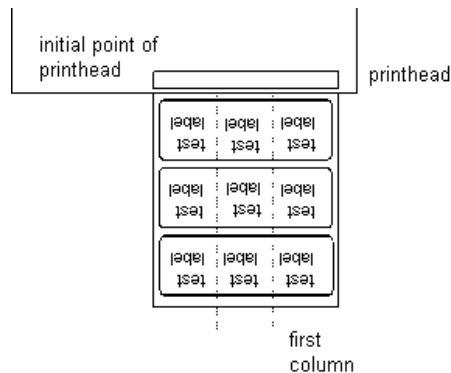

#### Setting the print of several columns

Press the key **F** to access the function menu.

Press the key **→** until the menu *Label layout* is displayed.

Press key **●** to confirm the selection.

Press the key **→** until the menu item *Width/Columns* is displayed.

Press the keys **▲** and **▼** to set the label width. The *Width* is the width of one column, e.g. 20.0 mm.

Press the keys **◀** and **▶** to move to the *Column* input field.

Press the keys **▲** and **▼** to change the number of columns, e.g. four columns with a label width of 20.0 mm.

Press the key **■** to start the print with input of number of labels and number of lines. The number of labels corresponds to the number of labels that should be printed.

e.g. Columns: 3, Items: 4

label 6	label 5	label 4
label 3	label 2	label 1

The first four labels were printed but not label 5 and 6.

## 11.2 Hotstart



### NOTICE!

The data is saved onto SD card. Therefore the SD card is a condition for the *Hotstart* menu item.

The function *Hotstart* contains e.g. that in case of a power failure the currently loaded label can be further processed without any loss of data. Moreover a print order can be interrupted and to be continued after switching on the printer anew.



### NOTICE!

At an active *Hotstart* all necessary data is stored on the SD card therefore do not remove the card during operation. When removing during operation, this causes the loss of all data on the SD card.

### Save current label

In case the *Hotstart* function is set to on, at the start of a print order the data of the current label is saved to the corresponding directory of the SD card.

However the following conditions have to be fulfilled:

- SD card inserted in drive A.
- Enough free storage space onto SD card.

An error message appears in case these conditions are not fulfilled.

### Save print order state

At switching off the printer the state of the current print order is saved to the corresponding directory of the SD card.

However the following conditions have to be fulfilled:

- SD card inserted in drive A.
- Enough free storage space onto SD card.

### Load label and print order state

When restarting the label printer (if the function *Hotstart* is activated) the saved label data and the status of print order were loaded from the corresponding file on the SD card. Because of this reason, when switching on the label printer a SD card has to be inserted in the appropriate drive. If the data cannot be loaded an error message appears.

**Start print order**

In case at switching off the label printer a print order was active, then a print start is released automatically and the required res. actual number of printed labels is refreshed.  
In case the print order was stopped at switching off the label printer, it is again set to the stopped mode after switching on the label printer anew.  
In case a customized entry was active during switching off the label printer, the window for the first customized variable is displayed.

**Refresh variable counter**

As in the intended file only the start values of the counter are saved, they are refreshed at a new start of the print order by means of the number of printed labels. Each counter is counted corresponding from its start value. Afterwards the position of the current and the next counter update are correctly set by means of the update intervals.

**NOTICE!**

Make sure that in case graphics are onto the label they have to be saved onto SD card.

### 11.3 Backfeed/Delay

#### Backfeed modes

In continuous dispenser mode (IO dynamic continuous, IO static continuous, IO photocell continuous) no optimised backfeed is possible. Because of the fact when changing the print order, then the current label in the offset sector is already printed from the old print order.

In the sector that is printed when preprint the following label, no date/time variable should be existing, because this could be refreshed before the next start impulse.

#### Standard

**Dispenser:** After printing the label, it is driven into the dispenser offset and waited there, until the label was removed (photocell) or a new start signal is given (IO dynamic). Afterwards it is again backtracked to the beginning of label and then the next label is printed.

**Cutter:** After printing the label, it is driven into the cutter offset; the label is cut and then backtracked immediately to the beginning of label (if an operating mode with backfeed is selected). Afterwards the next label is printed, if necessary.

**Tear-off edge:** After printing the last label of a print order it is driven into the tear-off offset and the label res. labels can be taken away. When starting a new print order, first it is backtracked again to the beginning of label and then the next label is printed.  
If a following print order is available before driving into the tear-off offset, then it is not driven into tear-off offset but the following label is directly printed.

#### Automatic

**Dispenser:** After printing the label it is driven into the dispenser offset and then backtracked to the beginning of label either immediately or after the set delay time. When releasing a new start signal (IO dynamic) the next label is immediately printed.

**Cutter:** This is the same function as for 'backfeed standard' as it is always backtracked immediately to the beginning of label.

**Tear-off edge:** After printing the last label of a print order it is driven into the tear-off offset and then backtracked to the beginning of label either immediately or after the set delay time. When starting a new print order then the next label is immediately printed.  
If a following print order is available before driving into the tear-off offset, then it is not driven into tear-off offset but the following label is directly printed.

<b>No backfeed</b>	<b>Dispenser:</b>	After printing the label it is driven into the dispenser offset and there waited. When releasing a new start signal (IO dynamic) then the next label is immediately printed. Because of the fact that the label is already in the offset, the label is only printed from beginning of offset position, i.e. at the definition of label an accordingly large range must be left free at the top margin of label, because these data are otherwise not printed.
	<b>Cutter:</b>	This is the same function as for 'backfeed standard' as it is always backtracked after cutting immediately to the beginning of label.
	<b>Tear-off edge:</b>	After printing the last label of a print order it is driven into the tear-off offset. When starting a new print order, the next label is immediately printed. Because of the fact that the label is already in the offset, the label is only printed from beginning of offset position, i.e. at the definition of label an accordingly large range must be left free at the top margin of label, because these data are otherwise not printed. If a following print order is available before driving into the tear-off offset, then it is not driven into tear-off offset but the following label is directly printed.
<b>Optimised backfeed</b>	<b>Dispenser:</b>	After printing the label, during driving into dispenser offset the following label is 'pre-printed', if this is already available (generated). When releasing a new start signal (IO dynamic) the already 'pre-printed' label is printed to the end and when driving into the dispenser offset the following label is again 'pre-printed'. In case the following label is not yet available or at the last label of a print order, the dispenser offset is driven as until now, and then for the next label before printing the backfeed to the beginning of label is executed.
	<b>Cutter:</b>	After printing the label, during driving into the cutter offset the following label is 'pre-printed', if this is already available (generated). After the cut it is not backtracked but the already 'pre-printed' label is printed to the end and when driving into the cutter offset the following label is again 'pre-printed'. If the following label is not yet available or at the last label of a print order, the cutter offset is driven as until now, then cut and afterwards the backfeed to the beginning of label is executed.
	<b>Tear-off edge:</b>	This is the same function as for 'backfeed standard' as it is only driven into the tear-off offset at the last label of a print order, if no following print order is available.

## 11.4 Photocells



### NOTICE!

When using reflection photocells you should observe that the label printer cover is closed and in this way other light (e.g. working lamp) on the photocell is prevented.

#### Transmission photocell normal

For this photocell type the transmitter is at the top res. the receiver at the bottom, i.e. the infra-red light is sent from the top. In this way the label detection is also from the top. This photocell type is used for standard adhesive labels with gap.

#### Reflexion photocell normal

For this photocell type the transmitter and receiver are at the bottom, i.e. the light is reflected by the label and taken over from the receiver. This photocell type is used for white (light) continuous labels with a black (dark) bar. The bar is the separator, i.e. it indicates the position of gap and in this way the label start.

#### Transmission photocell inverse

For this photocell type the transmitter is at the top res. the receiver at the bottom, i.e. the infra-red light is sent from the top. The label detection is, same as for the **transmission photocell normal**, from the top. However, it is printed differently as for normal photocells, in the translucent place; the label printer recognizes the opaque place as gap. This photocell type is used frequently when printing foils.

#### Reflexion photocell inverse

For this photocell type the transmitter and receiver are at the bottom, i.e. the light is reflected by the label and taken over from the receiver. This photocell type is used for black (dark) continuous labels with a white (light) bar. This bar is the separator, i.e. it indicates the position of gap and in this way the start of label.



### NOTICE!

When using transmission photocells inverse, the label printer must measure a difference of 2.5 V and for reflection photocells inverse 1 V between translucent and opaque material. Otherwise the label printer does not recognize a difference between label and gap (bar).



## 12 Environmentally-Friendly Disposal

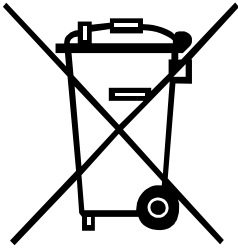

Manufacturers of B2B equipment are obliged to take back and dispose of old equipment that was manufactured after 13 August 2005. As a principle, this old equipment may not be delivered to communal collecting points. It may only be organised, used and disposed of by the manufacturer. Valentin products accordingly labelled can therefore be returned to Carl Valentin GmbH.

This way, you can be sure your old equipment will be disposed of correctly.

Carl Valentin GmbH thereby fulfils all obligations regarding timely disposal of old equipment and facilitates the smooth reselling of these products. Please understand that we can only take back equipment that is sent free of carriage charges.

The electronics board of the printing system is equipped with a battery. This must only be discarded in battery collection containers or by public waste management authorities.

Further information on the WEEE directive is available on our website [www.carl-valentin.de](http://www.carl-valentin.de).



## 13 Index

### B

backfeed/delay ..... 102, 103

### C

column printing ..... 99  
 connecting printer ..... 26  
 connector pin assignment, printer rear ..... 7  
 control inputs/control outputs ..... 18, 19, 20, 21, 22, 23, 24

### E

environmentally-friendly disposal ..... 105  
 error messages/error corrections ..... 89, 90, 91, 92, 93, 94, 95, 96, 97

### F

function menu  
   date/time ..... 53  
   device settings ..... 45, 46, 47, 48  
   emulation ..... 52  
   interface ..... 51  
   label layout ..... 43, 44  
   main menu ..... 58  
   menu structure ..... 38, 39, 40, 41  
   network ..... 48  
   password ..... 49, 50  
   print setting ..... 42  
   service functions ..... 54, 55, 56, 57

### H

hotstart ..... 100, 101

### I

initial operation ..... 27  
 installation ..... 25  
 instructions ..... 5  
 intended use ..... 5, 6

### L

loading media  
   cutter mode ..... 30  
   dispenser mode ..... 31, 32  
   fanfold material ..... 33  
   tear-off mode ..... 29

### M

maintenance/cleaning  
   general cleaning ..... 80  
   label photocell cleaning ..... 83  
   maintenance schedule ..... 79  
   pressure roller cleaning ..... 81  
   printhead adjusting ..... 87  
   printhead cleaning ..... 82  
   printhead replacing ..... 84, 85, 86  
   ribbon drawing roller, cleaning ..... 80  
 material loading ..... 29

**O**

operating conditions .....	10, 11, 12, 13
operation panel.....	37
options	
cutter .....	59, 60
dispenser I/O .....	61, 62, 63, 64
scanner .....	66, 67
WLAN.....	65

**P**

photocells .....	104
printhead adjusting	
parallelism.....	87
pressure.....	88
printhead, replacing.....	85, 86
product description .....	6

**S**

safety notes .....	9
SD card	
change directory .....	73
copying.....	77
define user directory .....	71, 72
delete file .....	75
display structure.....	69
filter .....	78
firmware update .....	78
formatting.....	76
load file.....	74
load layout .....	72
navigation .....	70
save configuration.....	75
save layout.....	74
setting up printer.....	25
switching on/off printer .....	26

**T**

technical data .....	15, 16, 17
transfer ribbon loading.....	34, 35

**U**

USB stick	
change directory .....	73
copying.....	77
delete file .....	75
display structure.....	69
filter .....	78
firmware update .....	78
load file.....	74
load layout .....	72
navigation .....	70
save configuration.....	75
save layout.....	74





---

Carl Valentin GmbH  
Neckarstraße 78 – 86 u. 94 . 78056 Villingen-Schwenningen  
Phone +49 7720 9712-0 . Fax +49 7720 9712-9901  
info@carl-valentin.de . www.carl-valentin.de